

# AVR 3700, AVR 370 AVR 2700, AVR 270

Audio/video receiver



Owner's Manual



INTRODUCTION	3	SET UP THE REMOTE CONTROL	24
SUPPLIED ACCESSORIES	3	INSTALL THE BATTERIES IN THE REMOTE CONTROL	24
IMPORTANT SAFETY INFORMATION	3	PROGRAM THE REMOTE TO CONTROL YOUR SOURCE DEVICES AND TV	24
PLACE THE RECEIVER	3	SET UP THE AVR	26
FRONT-PANEL CONTROLS	4	TURN ON THE AVR	26
REAR-PANEL CONNECTORS	6	USING THE ON-SCREEN MENU SYSTEM	25
SYSTEM REMOTE CONTROL FUNCTIONS	8	CONFIGURE THE AVR FOR YOUR SPEAKERS	26
ZONE 2 REMOTE CONTROL FUNCTIONS	10	SET UP YOUR SOURCES	27
INTRODUCTION TO HOME THEATER	12	SET UP THE NETWORK	28
TYPICAL HOME THEATER SYSTEM	12	OPERATING YOUR AVR	30
MULTICHANNEL AUDIO	12	CONTROLLING THE VOLUME	30
SURROUND MODES	12	MUTING THE SOUND	30
PLACE YOUR SPEAKERS	13	DOLBY® VOLUME	30
PLACING THE LEFT, CENTER AND RIGHT SPEAKERS	13	LISTENING THROUGH HEADPHONES	30
PLACING THE SURROUND SPEAKERS IN A 5.1-CHANNEL SYSTEM	13	SELECTING A SOURCE	31
PLACING THE SURROUND SPEAKERS IN A 7.1-CHANNEL SYSTEM	13	LISTENING TO FM AND AM RADIO	30
PLACING FRONT HEIGHT SPEAKERS IN A 7.1-CHANNEL SYSTEM	13	LISTENING TO MEDIA ON A USB DEVICE	32
PLACING THE SUBWOOFER	13	LISTENING TO AN iPod/iPhone/iPad DEVICE	32
TYPES OF HOME THEATER SYSTEM CONNECTIONS	14	LISTENING TO vTUNER (INTERNET RADIO)	33
SPEAKER CONNECTIONS	14	LISTENING TO MEDIA VIA YOUR HOME NETWORK	33
SUBWOOFER CONNECTIONS	14	SELECTING A SURROUND MODE	34
SOURCE DEVICE CONNECTIONS	14	AUDIO EFFECTS	34
VIDEO CONNECTIONS	15	VIDEO MODES	34
RADIO CONNECTIONS	16	ADVANCED FUNCTIONS	35
NETWORK CONNECTOR	16	AUDIO PROCESSING AND SURROUND SOUND	35
USB PORT	16	VIDEO PROCESSING	36
RS-232 CONNECTOR	16	MANUAL SPEAKER SETUP	38
MAKING CONNECTIONS	17	LISTENING IN ZONE 2	41
CONNECT YOUR SPEAKERS	17	SYSTEM SETTINGS	42
CONNECT YOUR SUBWOOFER	17	SETTINGS LOCK	43
CONNECT YOUR TV OR VIDEO DISPLAY	17	ADVANCED REMOTE CONTROL PROGRAMMING	44
CONNECT YOUR AUDIO AND VIDEO SOURCE DEVICES	18	RECORDING	44
CONNECT TO USB AND iOS DEVICES	20	SLEEP TIMER	44
CONNECT TO YOUR HOME NETWORK	20	RESETTING THE REMOTE	44
CONNECT THE RADIO ANTENNAS	20	PROCESSOR RESET	44
INSTALL A MULTIZONE SYSTEM	21	TROUBLESHOOTING	45
CONNECT IR EQUIPMENT (AVR 3650/AVR 365 ONLY)	22	SPECIFICATIONS	46
CONNECT THE TRIGGER OUTPUT	23	APPENDIX	47
CONNECT TO AC POWER	23		

## Introduction

### Thank you for choosing this Harman Kardon product!

For more than fifty years, the Harman Kardon mission has been to share a passion for music and entertainment, using leading-edge technology to achieve premium performance. Sidney Harman and Bernard Kardon invented the receiver, a single component designed to simplify home entertainment without compromising performance. Over the years, Harman Kardon products have become easier to use, while offering more features and sounding better than ever.

The AVR 3700/AVR 370 7.2-channel and AVR 2700/AVR 270 7.1-channel digital audio/video receivers continue this tradition with some of the most advanced audio and video processing capabilities yet, and a wealth of listening and viewing options.

To obtain the maximum enjoyment from your new receiver, please read this manual and refer back to it as you become more familiar with its features and their operation.

If you have any questions about this product, its installation or its operation, please contact your Harman Kardon retailer or custom installer, or visit the Web site at [www.harmankardon.com](http://www.harmankardon.com).

## Supplied Accessories

The following accessory items are supplied with your receiver. If any of these items are missing, please contact your Harman Kardon dealer or Harman Kardon customer service at [www.harmankardon.com](http://www.harmankardon.com).

- System remote control
- Zone 2 remote control (AVR 3700/AVR 370 only)
- EzSet/EQ™ microphone
- AM loop antenna
- FM wire antenna
- Six AAA batteries (AVR 3700/AVR 370); four AAA batteries (AVR 2700/AVR 270)
- AC power cord

## IMPORTANT SAFETY INFORMATION

### Verify Line Voltage Before Use

The AVR 3700 and AVR 2700 have been designed for use with 120-volt AC current. The AVR 370 and AVR 270 have been designed for use with 220 – 240-volt AC current. Connection to a line voltage other than that for which your receiver is intended can create a safety and fire hazard and may damage the unit. If you have any questions about the voltage requirements for your specific model, or about the line voltage in your area, contact your selling dealer before plugging the unit into a wall outlet.

### Do Not Use Extension Cords

To avoid safety hazards, use only the power cord supplied with your unit. We do not recommend that extension cords be used with this product. As with all electrical devices, do not run power cords under rugs or carpets, or place heavy objects on them. Damaged power cords should be replaced immediately by an authorized service center with a cord meeting factory specifications.

### Handle the AC Power Cord Gently

When disconnecting the power cord from an AC outlet, always pull the plug; never pull the cord. If you do not intend to use your receiver for any considerable length of time, disconnect the plug from the AC outlet.

### Do Not Open the Cabinet

There are no user-serviceable components inside this product. Opening the cabinet may present a shock hazard, and any modification to the product will void your warranty. If water or any metal object such as a paper clip, wire or staple accidentally falls inside the unit, disconnect it from the AC power source immediately, and consult an authorized service center.

### CATV or Antenna Grounding (AVR3700/AVR 2700)

If an outside antenna or cable system is connected to this product, be certain that it is grounded so as to provide some protection against voltage surges and static charges. Section 810 of the United States National Electrical Code, ANSI/NFPA No. 70-1984, provides information with respect to proper grounding of the mast and supporting structure, grounding of the lead-in wire to an antenna discharge unit, size of grounding conductors, location of antenna discharge unit, connection to grounding electrodes and requirements of the grounding electrode.

**NOTE TO CATV SYSTEM INSTALLER:** This reminder is provided to call the CATV (cable TV) system installer's attention to article 820-40 of the NEC, which provides guidelines for proper grounding and, in particular, specifies that the cable ground shall be connected to the grounding system of the building, as close to the point of cable entry as possible.

## Place the Receiver

- Place the receiver on a firm and level surface. Be certain that the surface and any mounting hardware can support the AVR's weight.
- Provide proper space above and below the AVR for ventilation. Recommended clearance distances are 30cm above the unit, 30cm behind the unit and 30cm on each side of the unit.
- If you install the AVR in a cabinet or other enclosed area, provide cooling air within the cabinet. Under some circumstances, a fan may be required.
- Do not obstruct the ventilation slots on the top of the receiver or place objects directly over them.
- Do not place the receiver directly on a carpeted surface.
- Do not place the receiver in moist or humid locations, in extremely hot or cold locations, in areas near heaters or heat registers, or in direct sunlight.

### Front-Panel Controls

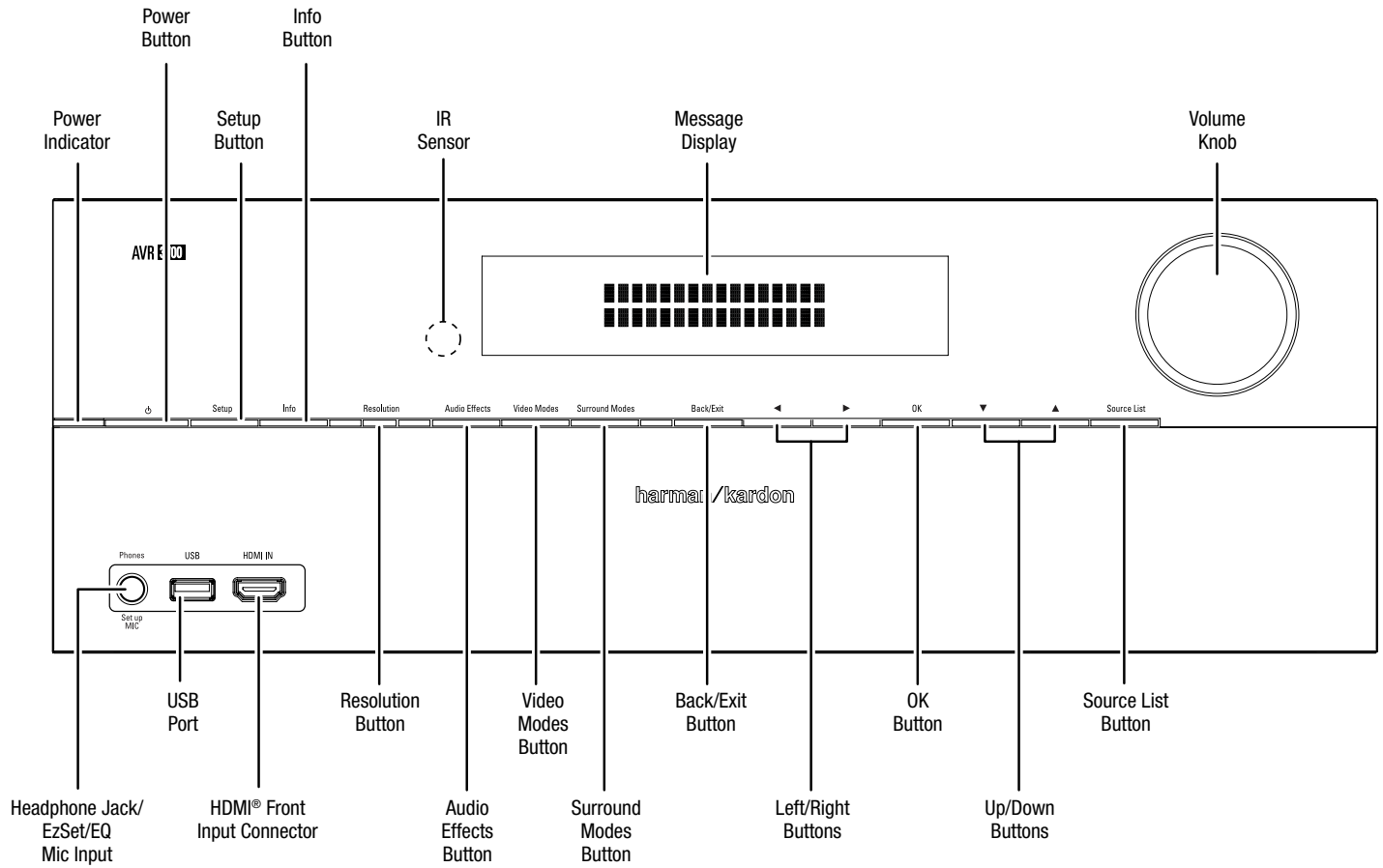

## Front-Panel Controls, continued

**Power indicator/Power button:** The AVR has four different power modes:

- **Off** (Power indicator not illuminated): When the rear-panel Main Power switch is in the Off position or the power cord is unplugged the AVR is off and will not respond to any commands. Plugging the power cord into a live AC outlet and setting the Main Power switch in the On position will put the AVR into the Eco Standby mode.
- **Eco Standby** (Power indicator glows solid amber): The Eco Standby mode minimizes energy consumption when you're not using the AVR. When the AVR is in Eco Standby, it will not automatically turn on or play audio in response to an AirPlay signal from a networked device. When the AVR is in Eco Standby, pressing the Power button turns it on. To put the AVR into Eco Standby when it is on, press the Power button for more than three seconds. NOTE: The AVR will not automatically enter the Eco Standby mode.
- **Standby** (Power indicator glows solid amber): The Standby mode mutes the AVR and shuts off its front-panel display, but allows the AVR to automatically turn on and play audio in response to an AirPlay signal from a networked device. When the AVR is in Standby, pressing the Power button turns it on. To put the AVR into Standby when it is on, press the Power button for less than three seconds. NOTE: The AVR will automatically enter the Standby mode whenever no control buttons have been pressed and no audio signal has been present for 30 minutes.
- **On** (Power indicator glows solid white): When the AVR is on it is fully operational.

**IMPORTANT NOTE:** If the PROTECT message ever appears on the AVR's front-panel message display, turn off the AVR and unplug it from the AC outlet. Check all speaker wires for a possible short-circuit (the "+" and "-" conductors touching each other or both touching the same piece of metal). If a short-circuit is not found, bring the unit to an authorized Harman Kardon service center for inspection and repair before using it again.

**Setup button:** Press this button to access the AVR's main menu.

**Info button:** Press this button to access the AVR's Source submenu, which contains the settings for the source currently playing. Use the Up/Down buttons to scroll through the different settings.

**Message display:** Various messages appear in this two-line display in response to commands and changes in the incoming signal. In normal operation, the current source name appears on the upper line, while the surround mode is displayed on the lower line. When the on-screen display menu system (OSD) is in use, the current menu settings appear.

**IR sensor:** This sensor receives infrared (IR) commands from the remote control. It is important to ensure that the sensor is not blocked. If covering the IR sensor is unavoidable (such as when the receiver is installed inside of a cabinet), connect an optional infrared receiver to the Remote IR In connector on the AVR's rear panel.

**Volume knob:** Turn this knob to raise or lower the volume.

**Headphone jack/EzSet/EQ Mic input:** Connect a 1/4" stereo headphone plug to this jack for private listening. This jack is also used to connect the supplied microphone for the EzSet/EQ procedure described in *Configure the AVR For Your Speakers*, on page 26.

**USB port:** You can use this port to play audio files from a connected Apple iOS device and play MP3 and WMA audio files from a USB device inserted into the USB port. You can also use this port to perform software upgrades that may be offered in the future. Do not connect a storage device, peripheral product or a PC here, unless you are instructed to do so as part of an upgrade procedure.

**HDMI (High-Definition Multimedia Interface®) Front Input connector:** Connect an HDMI-capable source component that will be used only temporarily, such as a camcorder or game console, here.

**Resolution button:** Press this button to access the AVR's video output resolution setting: 480p (AVR 3700/AVR 2700), 576p (AVR 370/AVR 270), 720p, 1080i, 1080p or 1080p/24Hz. Use the Up/Down and OK buttons to change the setting.

**IMPORTANT NOTE:** If you set the AVR's video output resolution higher than the capabilities of the actual connection between the AVR and your TV or video display, you will not see a picture. If you are using the composite video connection from the AVR to your TV (see *Connect Your TV or Video Display*, on page 17), the resolution will automatically be set to 480i.

**Audio Effects button:** Press this button to access the Audio Effects submenu, which allows you to adjust the AVR's tone controls and other audio controls. See *Set Up Your Sources*, on page 26, for more information.

**Video Modes button:** Press this button for direct access to the Video Modes submenu, which contains settings you can use to improve the video picture. Use the OK button to scroll through the different modes, and use the Up/Down and Left/Right buttons to make adjustments within each mode. See *Set Up Your Sources*, on page 26, for more information.

**Surround Modes button:** Press this button to select a listening mode. The Surround Modes menu will appear on screen, and the menu line will appear in the front-panel display. Use the Up/Down buttons to change the surround-mode category and the Left/Right buttons to change the surround mode for that category. See *Set Up Your Sources*, on page 26, for more information.

**Back/Exit button:** Press this button to return to the previous menu or to exit the menu system.

**Left/Right buttons:** Use these buttons to navigate the AVR's menus.

**OK button:** Press this button to select the currently highlighted item.

**Up/Down buttons:** Use these buttons to navigate the AVR's menus.

**Source List button:** Press this button to select a source device to watch/listen to. Use the Up/Down buttons to scroll through the source-device list, and press the OK button to select the source being displayed.

### Rear-Panel Connectors

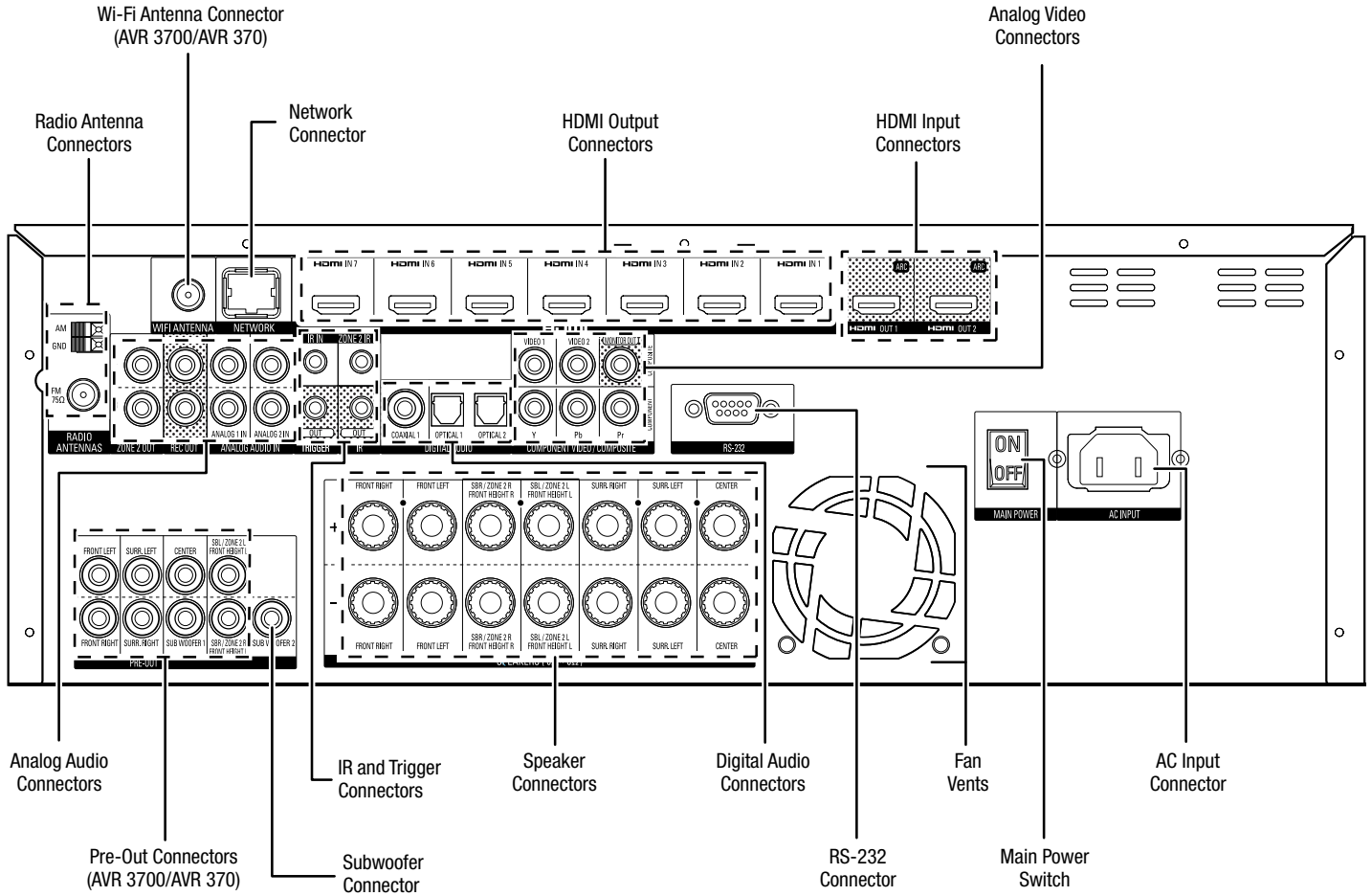

Rear-Panel Connectors (AVR 3700 shown)

## Rear-Panel Connectors, continued

**Radio Antenna connectors:** Connect the supplied AM and FM antennas to their respective terminals for radio reception.

**Wi-Fi® Antenna connector (AVR 3700/AVR 370):** If your home network is Wi-Fi, connect the supplied Wi-Fi antenna here to enjoy Internet radio and content from DLNA®-compatible devices that are connected to the network. You do not need to make a wired network connection.

**Network connector:** If your home network is wired, use a Cat. 5 or Cat. 5E Ethernet cable (not supplied) to connect the AVR's Network connector to your home network to enjoy Internet radio and content from DLNA-compatible devices that are connected to the network. See *Connect to Your Home Network*, on page 20, for more information.

**HDMI® Input connectors:** An HDMI connection transmits digital audio and video signals between devices. If your source devices have HDMI connectors, using them will provide the best possible video and audio performance quality. Since the HDMI cable carries both digital video and digital audio signals, you do not have to make any additional audio connections for devices you connect via the HDMI connection. See *Connect Your Audio and Video Source Devices*, on page 18, for more information.

**HDMI Output connectors:** If your TV has an HDMI connector, use an HDMI cable (not included) to connect it to the AVR's HDMI Out connector. The AVR will automatically transcode component and composite video input signals to the HDMI format (upscaling to as high as 1080p), so you do not need to make any other connections to your TV from the AVR or from any video source devices you connect to the AVR. **NOTE:** The AVR 3700 and AVR 370 have two HDMI Out connectors.

### Notes on using the HDMI Output connector:

- When connecting a DVI-equipped display to the HDMI Out connector, use an HDMI-to-DVI adapter and make a separate audio connection.
- Make sure the HDMI-equipped display is HDCP (High-bandwidth Digital Content Protection)-compliant. If it isn't, do not connect it via an HDMI connection; use an analog video connection instead and make a separate audio connection.

**Analog Video connectors:** The following Analog Video connectors are provided:

- **Composite Video Input connectors:** Use composite video connectors for video source devices that don't have HDMI or component video connectors. You will also need to make an audio connection from the source device to the AVR. See *Connect Your Audio and Video Source Devices*, on page 18, for more information.
- **Component Video Input connectors:** If any of your video source devices have component video connectors (and do not have HDMI connectors), using the component video connectors will provide superior video performance. You will also need to make an audio connection from the device to the receiver. See *Connect Your Audio and Video Source Devices*, on page 18, for more information.
- **Composite Video Monitor Out connector:** If your TV or video display does not have an HDMI connector, use a composite video cable (not included) to connect the AVR's Composite Video Monitor Out connector to your TV's composite video input. **NOTE:** The HDMI connection to your TV is preferred. If you use the composite video connection to your TV, you will not be able to view the AVR's on-screen menus.

**Analog Audio connectors:** The following analog audio connectors are provided:

- **Analog Audio Input connectors:** Use the AVR's Analog Audio Input connectors for source devices that don't have HDMI or digital audio connectors. See *Connect Your Audio and Video Source Devices*, on page 18, for more information.
- **Analog Rec[ord] Out connectors:** Connect this analog audio output to the analog audio input of a recording device. A signal is available at this output whenever an analog audio source is playing.
- **Zone 2 Out connectors:** Connect these jacks to an external amplifier to power the speakers in the remote zone of a multizone system.

**Pre-Out connectors (AVR 3700/AVR 370):** Connect these jacks to external amplifiers if more power is desired. The function of the Surround Back/Front Height/Zone 2 connectors is determined by the setting you make for the Assigned Amp. See *Manual Speaker Setup: Number of Speakers*, on page 38, for more information.

**Subwoofer connector:** Connect this jack to a powered subwoofer with a line-level input. See *Connect Your Subwoofer*, on page 17, for more information. **NOTE:** The AVR 3700 and AVR 370 have two subwoofer connectors.

**IR and Trigger connectors:** The following IR and trigger connectors are provided:

- **IR Remote In/Out connectors:** When the IR sensor on the front panel is blocked (such as when the AVR is installed inside a cabinet), connect an optional IR receiver to the IR Remote In jack. The IR Remote Out jack may be connected to the IR input of a compatible product to enable remote control through the AVR.
- **Zone 2 IR Input connector:** Connect a remote IR receiver located in Zone 2 of a multizone system to this jack to control the AVR (and any source devices connected to the Remote IR Output connector) from the remote zone.
- **12V Trigger connector:** This connector provides 12V DC whenever the AVR is on. It can be used to turn on and off other devices such as a powered subwoofer.

**Speaker connectors:** Use two-conductor speaker wire to connect each set of terminals to the correct speaker. See *Connect Your Speakers*, on page 17, for more information.

**NOTE:** The Assigned Amp speaker connectors are used for the surround back channels in a 7.1-channel home theater, or you can reassign them to a remote room for multizone operation or to front height channels for Dolby® Pro Logic IIz operation. See *Place Your Speakers*, on page XX, for more information.

**Digital Audio connectors:** If your non-HDMI source devices have digital outputs, connect them to the AVR's digital audio connectors. **NOTE:** Make only one type of digital connection (HDMI, optical or coaxial) from each device. See *Connect Your Audio and Video Source Devices*, on page 18, for more information.

**RS-232 connector:** This connector is used to connect to external control hardware. Consult a certified professional installer for more information.

**Fan Vents:** These vents are used by the AVR's fan to cool the system. Maintain a clearance of at least three inches (75mm) from the nearest surface to avoid overheating the unit. It is normal for the fan to remain off at most normal volume levels. An automatic temperature sensor turns the fan on only when it is needed.

**IMPORTANT NOTE:** Never block the fan vents. Doing so could allow the AVR to overheat to dangerous levels.

**Main Power switch:** This mechanical switch turns the AVR's power supply on or off. It is usually left on, and it cannot be turned on or off using the remote control.

**AC Input connector:** After you have made and verified all other connections, plug the supplied AC power cord into this receptacle and into an *unswitched* wall outlet.

### System Remote Control Functions

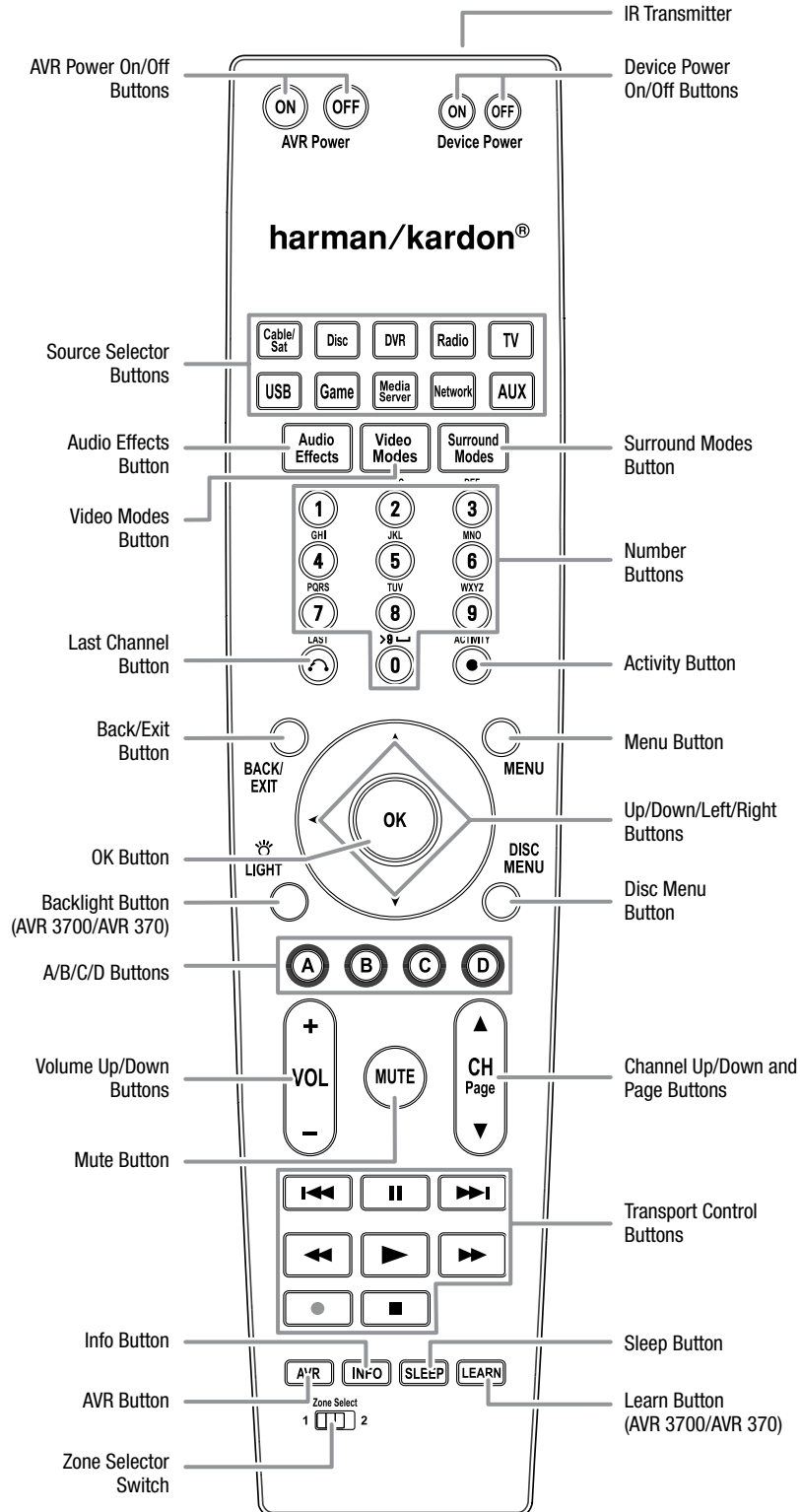



## System Remote Control Functions, continued

In addition to controlling the AVR, the AVR remote is capable of controlling eight other devices, including an iPod/iPhone device connected to the AVR's front-panel USB port. During the installation process, you may program the codes for each of your source components into the remote. (See *Program the Remote to Control Your Source Devices and TV*, on page 23, for programming information.) To operate a component, press its Source Selector button to change the remote's control mode.

A button's function depends on which component is being controlled. See Table A13 in the Appendix for listings of the functions for each type of component. Most of the buttons on the remote have dedicated functions, although the precise codes transmitted vary depending on the specific device being controlled. Due to the wide variety of functions for various source devices, we have included only a few of the most-often used functions on the remote: alphanumeric keys, transport controls, television-channel control, menu access and power on and off. Buttons dedicated to the AVR – AVR Power On/Off, Audio Effects, Video Modes, Surround Modes, Volume, Mute and Sleep Settings – are available at any time, even when the remote is controlling another device.

**AVR Power On/Off buttons:** Press these buttons to turn the AVR on and off. The Main Power switch on the AVR's rear panel must be on for this button to work.

**IR Transmitter:** As buttons are pressed on the remote, infrared codes are emitted through this opening.

**Device Power On/Off buttons:** Press a device's Source Selector button, then press these buttons to turn the device on and off.

**Source Selector buttons:** Press one of these buttons to select a source device, e.g., Disc, Cable/Sat, Radio, etc. This action will also turn on the AVR and switch the remote's control mode to operate the selected source device.

- The first press of the Radio button switches the AVR to the last-used tuner band (AM or FM). Each successive press changes the band.
- The first press of the USB button switches the AVR to the last-used source (USB or iPod). Each successive press cycles between the two sources.
- The first press of the Network button switches the AVR to the last-used source (Network or vTuner). Each successive press cycles between the two sources.

**Audio Effects button:** Press this button to access the Audio Effects submenu, which allows adjustment of the AVR's tone and other audio controls. See the *Set Up Your Sources* section, on page 26, for more information.

**Video Modes button:** Press this button for direct access to the Video Modes submenu, which contains picture adjustments you can use after you have adjusted the picture settings on your TV or video display. See the *Advanced Functions* section, on page 33, for more information.

**Surround Modes button:** Press this button to access the Surround Modes submenu. Select a surround-mode category: Auto Select, Virtual Surround, Stereo, Movie, Music or Game. When you select the category, it is highlighted and the surround mode changes.

To change the surround mode for the selected category, press the OK button when the menu line is highlighted and use the Up/Down buttons to select one of the available surround-mode options. Press the OK button; or press the Back/Exit button to exit the Surround Modes menu and display the next higher menu in the hierarchy. See the *Advanced Functions* section, on page 33, for more information.

**Number buttons:** Use these buttons to enter numbers for radio-station frequencies or to select station presets.

**Last Channel button:** When controlling a cable, satellite or HDTV set-top box or a TV, press this button to return to the previous television channel.

**Activity button:** With this button you can program the remote to store up to 11 different Macros (Activities). (A Macro is a series of commands that are transmitted by a single button press.) Execute a Macro by pressing this button, followed by the Number button (or the AVR Power On button) into which you programmed the Macro. See *Programming Macro (Activity) Commands*, on page 41, for more information.

**Back/Exit button:** Press this button to return to the previous menu or to exit the menu system.

**Menu button:** This button is used within the tuner menus and an iPod connected to the AVR's front-panel USB port, and is also used to display the main menu on some source devices. To display the AVR's menu system, press the AVR button.

**Up/Down/Left/Right buttons:** These buttons are used to navigate the menu system and to operate the tuner.

**OK button:** This button is used to select items from the menu system.

**Backlight button (AVR 3700/AVR 370):** Press this button to illuminate the buttons on the remote. Press it again to turn the backlight off, or wait 5 seconds after the last button press for the light to turn off on its own.

**Disc Menu button:** To display the disc's menu while a DVD or Blu-ray Disc is playing, press the Disc Source Selector button, then press this button.

**A/B/C/D buttons:** These buttons can be used as additional source buttons and can also operate certain functions when used with some source devices. See Table A13 in the Appendix for details. These buttons are also used with a Teletext®-capable television if your broadcast, cable or satellite provider offers Teletext service.

**Volume Up/Down buttons:** Press these buttons to raise or lower the volume.

**Channel Up/Down and Page buttons:** When the tuner has been selected, press these buttons to select a preset radio station. While operating a cable, satellite or HDTV set-top box or a television, press these buttons to change channels.

**Mute button:** Press this button to mute the AVR's speaker-output connectors and headphone jack. To restore the sound, press this button or adjust the volume.

**Transport Control buttons:** These buttons are used to control source devices.

**Info button:** Press to display the AVR's Info Menu, which contains the settings for the current source.

**AVR button:** Press to display the AVR's Main Menu.

**Sleep button:** Press this button to activate the sleep timer, which turns off the receiver after a programmed period of time. Each press increases the time by 10 minutes, up to 90 minutes – ending with the "Sleep Off" message.

**Learn button (AVR 3700/AVR 370):** The AVR 3700/AVR 370 remote is capable of "learning" individual IR codes from the original remote that came with a source device. See *Program the Remote to Control Your Source Devices and TV*, on page 23, for more information.

**Zone Selector switch:** Use this switch to select whether the AVR commands will affect the main listening area (Zone 1) or the remote zone of a multizone system (Zone 2). For normal operation, leave the switch in the Zone 1 position.

### Zone 2 Remote Control Functions (AVR 3700/AVR 370 only)

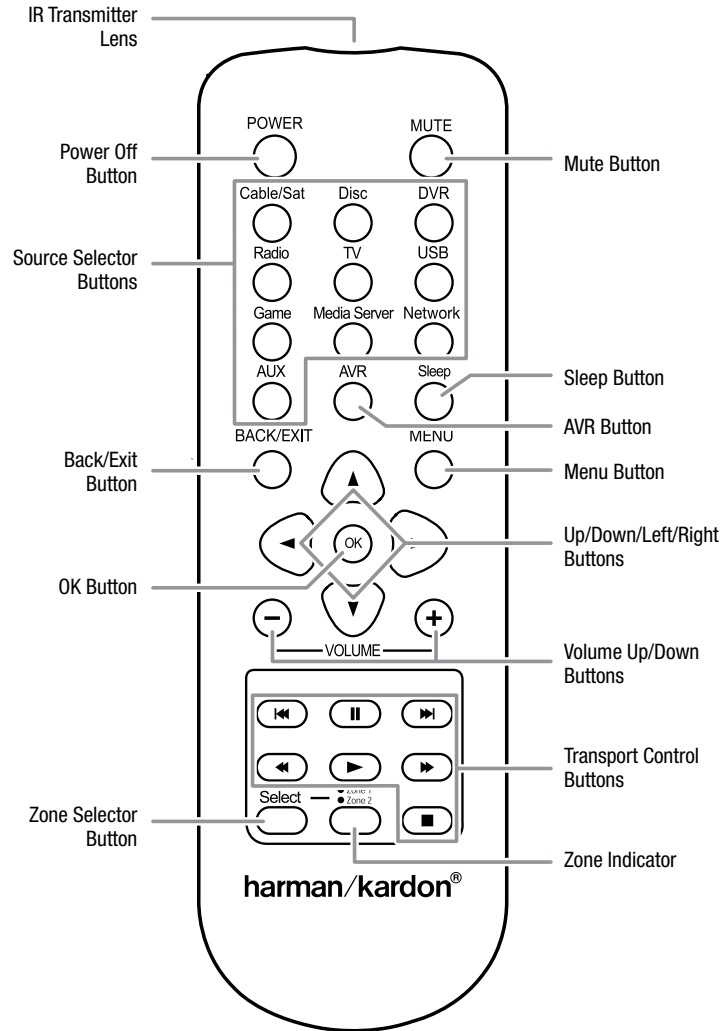

## Zone 2 Remote Control Functions (AVR 3700/AVR 370 only), continued

By installing an IR receiver in the remote zone of a multizone system and connecting it to the AVR's Zone 2 IR Input connector, you can use the Zone 2 remote to control the sound in the remote zone from within the remote zone. You can use it to control the AVR's power, volume and mute functions or to select a source input for the remote zone, and to control a Harman Kardon source device connected to one of the AVR's Remote IR Out connectors. See *Connect IR Equipment*, on page 22, for more information.

You can also use the Zone 2 remote in the main listening room to control the AVR and Harman Kardon Blu-ray Disc™, DVD, CD or tape players. When the Zone 2 remote is in the Zone 1 control mode (the remote's Zone Indicator light will turn green), its power, volume and mute controls will affect only the main listening area. To restore operation to the remote zone, press the remote's Zone Selector button so that its Zone Indicator light turns red.

**IR Transmitter lens:** As buttons are pressed on the remote, infrared codes are emitted through this lens.

**Power Off button:** Press this button to turn the AVR off.

**Mute button:** Press to mute the AVR's remote-zone speakers. To restore the sound, press this button, adjust the volume or turn off the multizone system. Make sure to switch the remote to Zone 2 mode so that only the remote zone will be affected.

**Source Selector buttons:** With the remote in Zone 2 mode, press one of these buttons to select a source device for the remote zone. Pressing the button will also turn on the multizone system and switch the remote to the selected source device's control mode. You may select a different external source device than that for the main room, but not different tuner bands. If you select the same source as that for the main room, any commands sent to the source device will affect both zones.

- The first press of the Radio button switches the AVR to the last-used tuner band (AM or FM). Each successive press changes the band.
- The first press of the USB button switches the AVR to the last-used source (USB or iPod). Each successive press cycles between the two sources.
- The first press of the Network button switches the AVR to the last-used source (Network or vTuner). Each successive press cycles between the two sources.

**Sleep button:** Press this button to activate the sleep timer, which turns off the receiver after a programmed period of time. Each press increases the time by 10 minutes, up to 90 minutes – ending with the “Sleep Off” message.

**AVR button:** Press this button to turn on the AVR and select the last-used source. This button is also used to switch the remote control to AVR control mode.

**Back/Exit button:** Press this button to return to the previous menu or to exit the menu system.

**Menu button:** This button is used within the tuner menus and is also used to display the main menu on some source devices. To display the AVR's menu system, press the AVR button.

**Up/Down/Left/Right buttons:** These buttons are used to navigate the menu system and to operate the tuner.

**OK button:** This button is used to select items from the menu system.

**Volume Up/Down buttons:** Press to raise or lower the volume level in the remote zone.

**Transport Control buttons:** These buttons are used to control source devices.

**Zone Selector button and Zone Indicator light:** Each press of the Zone Selector button determines whether the AVR commands will affect the main listening area (Zone 1) or the remote zone (Zone 2). The Zone Indicator light will turn green when Zone 1 has been selected, and red when Zone 2 has been selected. The Zone Indicator light will also light up briefly when any button is pressed.

## Introduction to Home Theater

This introductory section will help you to familiarize yourself with some basic concepts unique to multichannel surround-sound receivers, which will make it easier for you to set up and operate your AVR.

### Typical Home Theater System

A home theater typically includes an audio/video receiver, which controls the system and supplies amplification for the loudspeakers; a disc player; a source component for television broadcasts (cable box, satellite dish receiver, HDTV tuner or antenna connected to the TV); a TV or video display; and multiple loudspeakers.

### Multichannel Audio

The main benefit of a home theater system is its ability to produce “surround sound.” Surround sound uses multiple speakers and amplifier channels to immerse you in the audio/video presentation for a dramatically increased sense of realism.

Your AVR may have up to seven main speakers connected directly to it, plus a subwoofer. Each main speaker is powered by its own amplifier channel inside the AVR. A system with more than two speakers is called a multichannel system. The different main speaker types in a home theater system are:

- **Front Left and Right:** The front left and right speakers are used as in a two-channel system. In many surround-sound modes, these speakers are secondary, while the main action, especially dialogue, is reproduced by the center speaker.
- **Center:** When you are watching movies and television programs, the center speaker reproduces most of the dialogue and other soundtrack information, anchoring it with the picture. When you are listening to a musical program, the center speaker helps to create a seamless front soundstage, creating a realistic “you-are-there” listening experience.
- **Surround Left and Right:** The surround left and right speakers produce ambient sounds that help create a realistic and immersive surround-sound environment. They also help recreate directional sound effects such as aircraft flyovers.
- **Surround Back Left and Right:** Surround back channel speakers are used with surround modes such as the Dolby Digital EX, Dolby Digital Plus, Dolby TrueHD, DTS-ES® (Discrete and Matrix), DTS-HD™ High Resolution Audio, DTS-HD Master Audio™ and Logic 7® 7.1 modes that are designed for 7.1-channel systems.
- **Front Height Left and Right:** Your AVR includes Dolby Pro Logic IIz decoding, which uses the AVR's Assigned Amp channels as front height channels. The addition of front height channels – an additional pair of speakers positioned above the front left and right speakers – produces a surround-sound experience with added depth and dimension by creating lifelike sound that comes at you from varying heights.

NOTE: You can set up your system to use either surround back speakers or front height speakers; you cannot use both.

The surround back channel speakers are optional. If your system does not include surround back left and right speakers, you can set up your AVR with a 5.1-channel surround-sound system in the main listening area, and you can reassign the surround back channel amplifiers to power loudspeakers located in another room in a multizone system. (Alternately, you can reassign the surround back channel amplifiers to power front height speakers for use with Dolby Pro Logic IIz. See *Manual Speaker Setup*, on page 36, for more information.)

Many people expect the surround speakers to play as loudly as the front speakers. Although you will calibrate all of the speakers in your system to sound equally loud at the listening position, most artists use the surround speakers for ambient effects only, and they create their programs to steer relatively little sound to these speakers.

- **Subwoofer:** A subwoofer is designed to play only the lowest frequencies (the deep bass). It augments smaller, limited-range main speakers that are usually used for the other channels. Many digital-format programs, such as movies recorded in Dolby Digital, contain a low-frequency effects (LFE) channel that is directed to the subwoofer. The LFE channel packs the punch of a rumbling train or airplane, or the power of an explosion, adding realism and excitement to your home theater. Some people use two subwoofers for additional power and for even distribution of the sound.

### Surround Modes

There are different theories as to the best way to present surround sound and to distribute each audio channel's sounds to the surround-sound system's speakers. A variety of algorithms have been developed in an effort to recreate the way we hear sounds in the real world, resulting in a rich variety of options. Several companies have developed different surround-sound technologies, all of which can be accurately reproduced by your AVR:

- **Dolby Laboratories:** Dolby TrueHD, Dolby Digital Plus, Dolby Digital, Dolby Digital EX, Dolby Pro Logic® IIx and IIz.
- **DTS:** DTS-HD High Resolution Audio, DTS-HD Master Audio, DTS, DTS-ES (Discrete and Matrix), DTS Neo:6®, DTS 96/24™.
- **HARMAN International:** Logic 7®, HARMAN virtual speaker, HARMAN headphone.
- **Stereo Modes:** Generic modes that expand upon conventional two-channel stereo, including 5CH and 7CH Stereo.

Appendix Table A12, on page 50, contains detailed explanations of the different surround-sound options available on your AVR. Digital surround-sound modes, such as the Dolby Digital and DTS modes, are available only on specially encoded programs, such as those available via HDTV, DVD and Blu-ray Disc media and digital cable or satellite television. Other surround modes may be used with digital and analog signals to create a different surround presentation or to use a different number of speakers. Surround-mode selection depends upon the number of speakers in your system, the program you are watching or listening to, and your personal tastes.

## Place Your Speakers

Determine the locations for your system's speakers according to their manufacturer's directions and the layout of your listening room. Use the illustrations below as a guide for 7.1-channel and 5.1-channel systems.

To create the most realistic surround-sound environment possible, you should place your speakers in a circle with the listening position at its center. You should angle each speaker so it directly faces the listening position. Use the diagrams below as a guide.

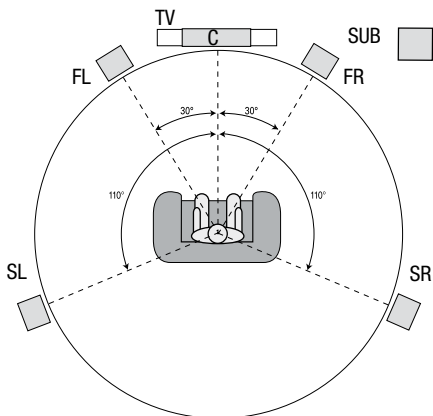

Speaker Positioning for 5.1-Channel Systems

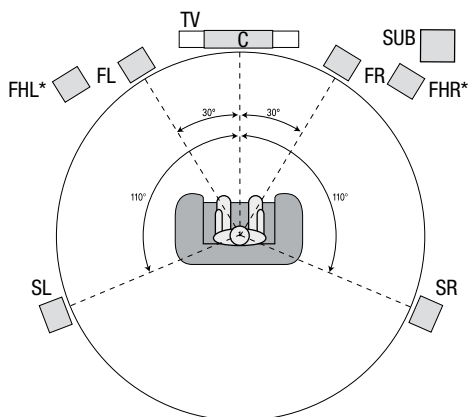
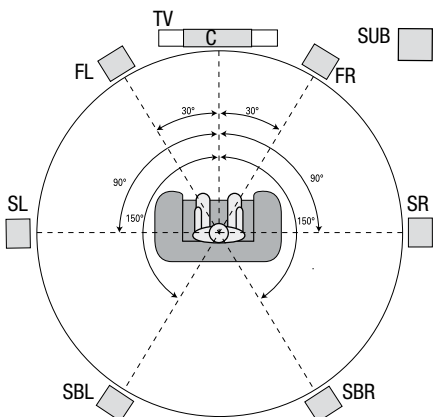

\* FHL and FHR speakers should be at least 3 ft (0.9m) above the FL and FR speakers.

Speaker Positioning for 7.1-Channel Systems

(Top: with Surround Back Speakers; Bottom: with Front Height Speakers)

**NOTE:** In a 7.1-channel system, you must choose to use either surround back speakers or front height speakers – you cannot use both simultaneously.

### Placing the Left, Center and Right Speakers

Place the center speaker either on top of, below or mounted on the wall above or below the TV or video display screen. Place the front left and right speakers along the circle, about 30 degrees from the center speaker and angled toward the listener.

Place the front left, front right and center speakers at the same height, preferably at about the same height as the listener's ears. The center speaker should be no more than 2 feet (0.6m) above or below the left/right speakers. If you're using only two speakers with your AVR, place them in the front left and right positions.

### Placing the Surround Speakers in a 5.1-Channel System

You should place the left and right surround speakers approximately 110 degrees from the center speaker, slightly behind and angled toward the listener. Alternatively, place them behind the listener, with each surround speaker facing the opposite-side front speaker. You should place the surround speakers 2 feet – 6 feet (0.6m – 1.8m) higher than the listener's ears.

### Placing the Surround Speakers in a 7.1-Channel System

In a 7.1-channel system, place the side surround speakers 90 degrees from the center speaker, directly to either side of the listening position. Place the surround back left and right speakers 150 degrees from the center speaker, directly facing the opposite-side front speaker. You should place all the surround speakers 2 feet – 6 feet (0.6m – 1.8m) higher than the listener's ears.

### Placing Front Height Speakers in a 7.1-Channel System

Your AVR includes Dolby Pro Logic IIz decoding, which uses the AVR's Assigned Amp channels as front height channels. The addition of front height channels – an additional pair of speakers positioned above the front left and right speakers – produces a surround-sound experience with added depth and dimension by creating lifelike sound that comes at you from varying heights.

We recommend placing front height speakers at least 3 feet (0.9m) higher than the front left and front right speakers, and directly above or farther apart than the front left and right speakers. The higher and further apart you place the front height speakers, the more you should angle them down and in toward the listening position.

**NOTE:** Your receiver will sound its best when the same model or brand of loudspeaker is used for all positions.

### Placing the Subwoofer

Because a room's shape and volume can have a dramatic effect on a subwoofer's performance, it is best to experiment with placement so that you will find the location that produces the best results in your particular listening room. With that in mind, these rules will help you get started:

- Placing the subwoofer next to a wall generally will increase the amount of bass in the room.
- Placing the subwoofer in a corner generally will maximize the amount of bass in the room.
- In many rooms, placing the subwoofer along the same plane as the left and right speakers can produce the best integration between the sound of the subwoofer and that of the left and right speakers.
- In some rooms, the best performance could even result from placing the subwoofer behind the listening position.

A good way to determine the best location for the subwoofer is by temporarily placing it in the listening position and playing music with strong bass content. Move around to various locations in the room while the system is playing (putting your ears where the subwoofer would be placed), and listen until you find the location where the bass performance is best. Place the subwoofer in that location.

### Types of Home Theater System Connections

There are different types of audio and video connections used to connect the AVR to your speakers, your TV or video display, and your source devices. The Consumer Electronics Association has established the CEA® color-coding standard.

Analog Audio Connection	Color
Front Left/Right	White/Red
Center	Green
Surround Left/Right	Blue/Gray
Surround Back/Front Height Left/Right	Brown/Tan
Subwoofer	Purple

Digital Audio Connection	Color
Coaxial (input or output)	Orange
Optical Input	Black
Optical Record Output	Gray

Analog Video Connection	Color
Component Video	Red/Green/Blue
Composite Video	Yellow

### Speaker Connections

Speaker cables carry an amplified signal from the AVR's speaker terminals to each loudspeaker. They contain two wire conductors, or leads, that are differentiated in some way, such as with colors or stripes.

The differentiation helps you maintain proper polarity, without which your system's low-frequency performance can suffer. Each speaker is connected to the AVR's speaker-output terminals using two wires, one positive (+) and one negative (-). Always connect the positive terminal on the speaker, which is usually colored red, to the positive terminal on the receiver, which is colored as indicated in the Connection Color Guide Table, above. The negative terminals on the speakers and the AVR are black.

Your AVR uses binding-post speaker terminals that can accept bare-wire cables or banana plugs. Bare-wire cables are installed as shown below:

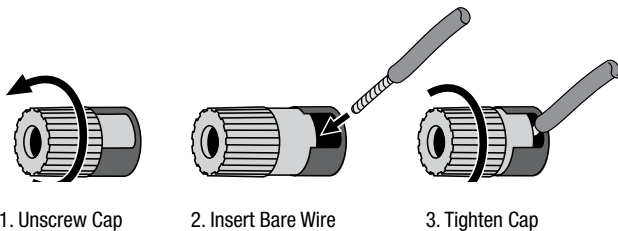

Banana plugs are inserted into the hole in the middle of the terminal cap, as shown below:

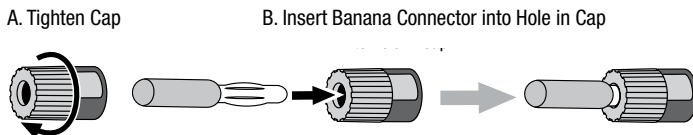

Always connect the colored (+) terminal on the AVR to the (+) terminal on the speaker (usually red), and the black (-) terminal on the AVR to the (-) terminal on the speaker (usually black).

**IMPORTANT: Make sure the (+) and (-) bare wires do not touch each other or the other terminal. Touching wires can cause a short circuit that can damage your receiver or amplifier.**

### Subwoofer Connections

The subwoofer is a speaker dedicated to reproducing only the low (bass) frequencies, which require more power. To obtain the best results, most speaker manufacturers offer powered subwoofers that contain their own amplifiers. Use a single RCA audio cable to make a line-level (non-amplified) connection from the AVR's Subwoofer connector to a corresponding input jack on the subwoofer.

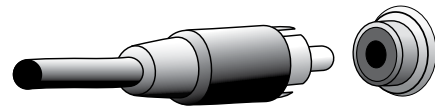

Although the AVR's purple subwoofer output looks similar to a full-range analog audio jack, it is filtered so that only the low frequencies pass through it. Don't connect this output to any device other than a subwoofer.

### Source Device Connections

Audio and video signals originate in source devices (components where a playback signal originates) such as your Blu-ray Disc or DVD player, CD player, DVR (digital video recorder) or other recorder, tape deck, game console, cable or satellite television tuner, an iPod or iPhone (connected to the AVR's USB port) or an MP3 player. The AVR's FM/AM tuner also counts as a source, even though no external connections are needed other than the FM and AM antennas. Separate connections are required for the audio and video portions of the source device's signal, except for digital HDMI connections. The types of connections you use will depend upon the capabilities of the source device and of your TV or video display.

### Digital Audio Connections – HDMI

There are two types of audio connections – digital and analog. Digital audio signals are required for listening to sources encoded with digital surround modes, such as Dolby Digital and DTS, or for uncompressed PCM digital audio. Your AVR has three types of digital audio connections: HDMI, coaxial and optical. Do not use more than one type of digital audio connection for each source device. However, it's okay to make both analog and digital audio connections to the same source.

Your AVR is equipped with seven rear-panel HDMI input connectors, and one HDMI monitor output connector. (The AVRs also have a front-panel HDMI input connector.) HDMI technology enables digital audio and video information to be carried using a single cable, delivering the highest quality picture and sound. If your TV or video display device has an HDMI input connector, make a single HDMI connection from each source device to the AVR. Usually, a separate digital audio connection is not required.

The AVR's HDMI output connection contains an Audio Return Channel (ARC) that carries a digital audio signal from your TV or video display back to the AVR. It allows you to listen to HDMI devices that are connected directly to your TV (such as an Internet connection) without making an additional connection from the device to the AVR. The ARC signal is active when the TV source is selected. See *System Settings*, on page 39, for more information. (The AVR 3700 and AVR 370 have two HDMI output connections.)

The HDMI connector is shaped for easy plug-in (see illustration, below), and HDMI cable runs are limited to about 10 feet (3m). If your video display has a DVI input and is HDCP-compliant, use an HDMI-to-DVI adapter (not included), and make a separate audio connection.

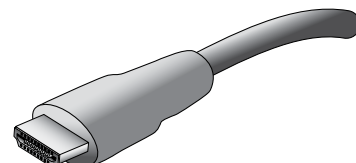

### Digital Audio Connections – Coaxial

Coaxial digital audio jacks are usually color-coded in orange. Although they look like standard RCA-type analog jacks, you should not connect coaxial digital audio outputs to analog inputs or vice versa.

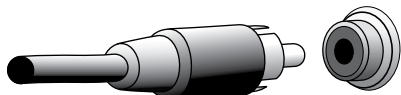

### Digital Audio Connections – Optical

Optical digital audio connectors are normally covered by a shutter to protect them from dust. The shutter opens as the cable is inserted. Optical input connectors are color-coded using a black shutter, while optical outputs use a gray shutter.

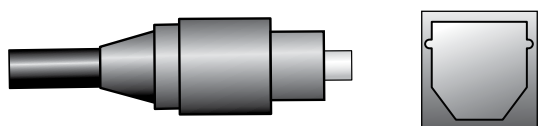

### Analog Audio Connections

Two-channel analog connections require a stereo audio cable, with one connector for the left channel (white) and one for the right channel (red). These two connectors are attached to each other.

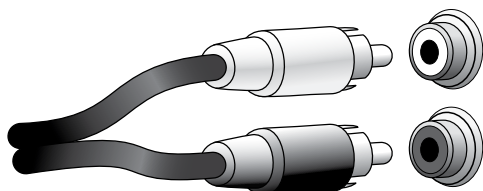

For source devices that have both digital and analog audio outputs, you may make both connections. If you are going to be setting up a multizone system, remember that Zone 2 is an audio-only zone (the AVR does not have a Zone 2 video output). Therefore, make analog connections for any audio source devices (such as a CD changer) that you will want available for listening in Zone 2 at all times.

The analog connections also feed the analog record outputs. You may record materials from Blu-ray Disc recordings, DVDs or other copy-protected sources using only analog connections. Remember to comply with all copyright laws if you choose to make a copy for your own personal use.

### Video Connections

Many source devices output both audio and video signals (e.g., Blu-ray Disc, DVD player, cable television box, HDTV tuner, satellite box, VCR, DVR). In addition to an audio connection as described above, make a video connection for each of these source devices. Make only one type of video connection for each device.

#### Digital Video Connections

If you have already connected a source device to one of the AVR's HDMI input connectors, you have automatically made a video connection for that device, since the HDMI cable carries both digital audio and digital video signals.

#### Analog Video Connections – Composite Video

Your AVR uses two types of analog video connections: composite video and component video.

Composite video is the basic connection most commonly available. Both the chrominance (color) and luminance (intensity) components of the video signal are transmitted using a single cable. The jack is usually color-coded yellow and looks like an analog audio jack. Do not connect a composite video jack to an analog audio or coaxial digital audio jack, or vice versa.

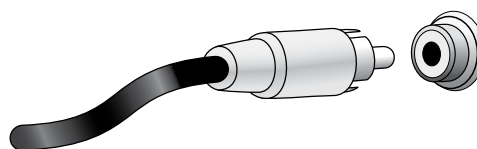

#### Analog Video Connections – Component Video

Component video separates the video signal into three components – one luminance (“Y”) and two sub-sampled color signals (“Pb” and “Pr”) – that are transmitted using three separate cables that are color-coded green (Y), blue (Pb) and red (Pr). Component video cables that join three separate green, blue and red connectors into a single cable are sold separately.

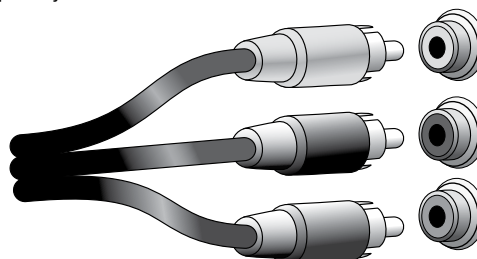

If your TV or video display has an HDMI connection, we recommend it as the best quality connection. Your AVR converts composite and component analog video input signals to the HDMI format, upscaling them to high-definition 1080p resolution.

### Radio Connections

Your AVR uses separate terminals for the included FM and AM antennas. The FM antenna uses a 75-ohm F-connector.

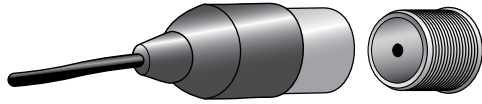

The AM antenna connector uses spring-clip terminals. After assembling the antenna as shown below, press the levers to open the connectors, insert the bare wires into the openings, and release the levers to secure the wires. The antenna wires are not polarized, so you can insert either wire into either connector.



### Network Connector

The AVR's Network connector allows you to enjoy Internet radio or content from other DLNA-compatible devices that are connected to the same network. Use a Cat. 5 or Cat. 5E Ethernet cable to connect the AVR's RJ-45 connector to your home network.

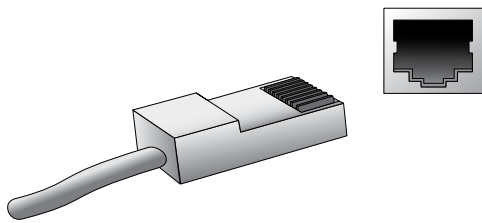

### USB Port

The AVR can play audio files from an Apple iOS® device connected to the USB port, and allows you to control the iOS device via the AVR remote control. The AVR can also play MP3 and WMA audio files from a USB device inserted into the USB port. Insert the connector or device into the USB port oriented so it fits all the way into the port. You may insert or remove the connector or device at any time – there is no installation or ejection procedure.

The USB port on your AVR is also used to perform firmware upgrades. If an upgrade for the AVR's operating system is released in the future, you will be able to download it to the AVR using this port. Complete instructions will be provided at that time.

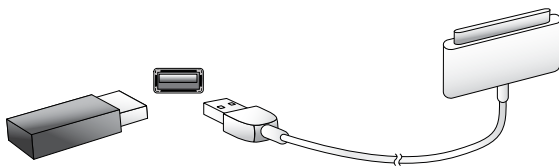

**IMPORTANT: Do not connect a PC or other USB host/controller to the AVR's USB port, or you may damage both the AVR and the other device.**

### RS-232 Connector

Your AVR's RS-232 serial port may be connected to an external control system to allow it to transmit control commands to the AVR. The port is bidirectional so that the AVR can transmit status updates to the control device. Connecting and using the RS-232 port requires considerable technical knowledge and is best left to a professional custom installer.

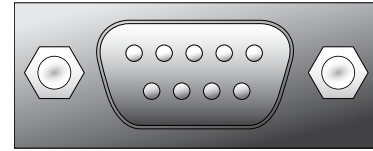



## Making Connections

**CAUTION:** Before making any connections to the audio/video receiver, ensure that the AVR's AC cord is unplugged from the receiver and the AC outlet. Making connections with the receiver plugged in and turned on could damage the speakers.

### Connect Your Speakers

After you have placed your loudspeakers in the room as explained in *Place Your Speakers*, on page 13, connect each speaker to its color-coded terminal on the AVR as explained in *Speaker Connections*, on page 14. Connect the speakers as shown in the illustration.

Connect Surround Back L/R Speakers  
-OR- Front Height L/R Speakers Here

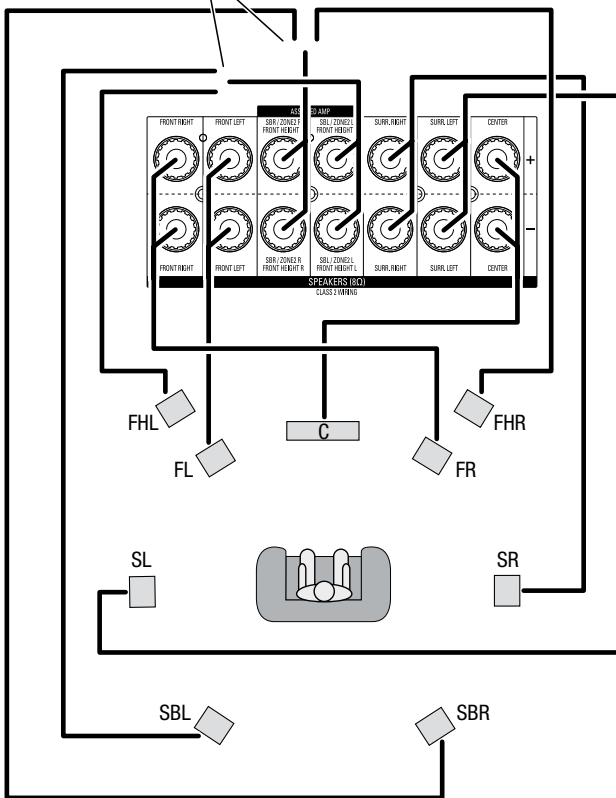

**NOTE:** If you installed front height speakers, connect them as shown for the SBL and SBR speakers.

### Connect Your Subwoofer

Use a single RCA audio cable to connect the AVR's Subwoofer connector to your subwoofer as explained in *Subwoofer Connections*, on page 14. **NOTE:** The AVR 3700 and AVR 370 provide connections for two subwoofers. See *Manual Speaker Setup: Number of Speakers*, on page XX, for information about activating the two subwoofer outputs. Consult your subwoofer's user manual for specific information about making connections to it.

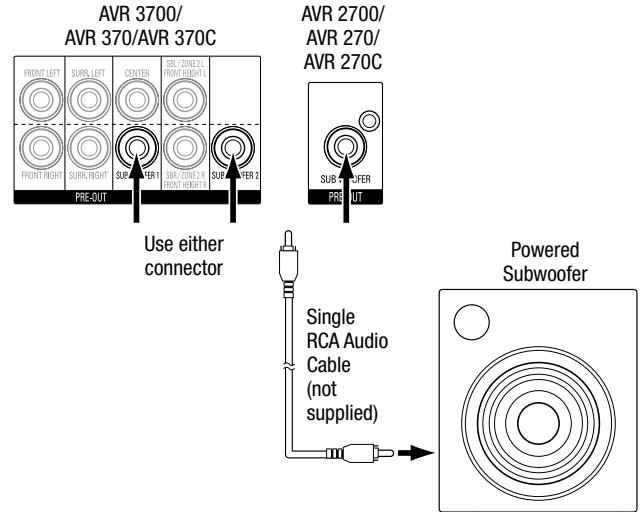

### Connect Your TV or Video Display

If your TV has an HDMI connector: Use an HDMI cable (not included) to connect it to the AVR's HDMI Monitor Out connector. The AVR 3700 and AVR 370 provide HDMI connections for two TVs. You do not need to make any other connections to your TV from the receiver or from any of your video source components.

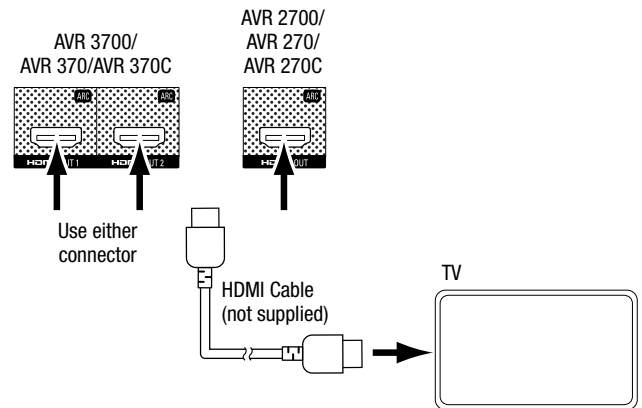

**If your TV does not have an HDMI connector:** Use a composite video cable (not included) to connect the AVR's Composite Monitor Out connector to your TV's composite video connector.

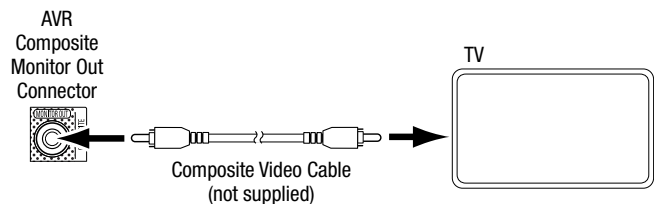

**NOTE:** The HDMI connection to your TV is preferred. If you use the composite video connection to your TV, you will not be able to view the AVR's on-screen menus.

### Connect Your Audio and Video Source Devices

Source devices are components where a playback signal originates, e.g. a Blu-ray Disc™ or DVD player; a cable, satellite or HDTV tuner; etc. Your AVR has several different types of input connectors for your audio and video source devices: HDMI, component video, composite video, optical digital audio, coaxial digital audio and analog audio. The connectors are not labeled for specific types of source devices; they are labeled numerically, so you can connect your devices according to your individual system's make-up.

Your AVR's various source buttons have default assignments to different input connectors (listed in the "Default Connector(s)" column of the table below). For ease of setup, you should connect each source device to the connector where the corresponding default source button is assigned (e.g., connect your Blu-ray Disc player to HDMI 1).

However, you can connect your source devices as you wish and re-assign any of the input connections to any of the Source Buttons listed in the table according to where you actually connect each of your source devices.

As you connect your various source devices, fill out the "Connected Component" column in the table – it will make it easier for you to assign the various source buttons after you have completed making all of the connections. (You will make any changes to the source-button assignments and fill in the "Assigned Connector(s)" column later in the setup process.)

Note: You cannot assign connectors to the Network, Radio and USB source buttons.

Source Button	Default Connector(s)	Assigned Connector(s)	Connected Device
Disc	HDMI 1		
Cable/Sat	HDMI 2		
Game	HDMI 3		
Media Server	HDMI 4		
DVR	HDMI 5		
TV	None/Optical Digital Audio 1		
Aux	HDMI Front		
A (red)	HDMI 6		
B (green)	HDMI 7		
C (yellow)	Composite Video 1/Analog Audio 1		
D (blue)	Composite Video 2/Analog Audio 2		

Monitor Output Connector	_____	_____	Connected Device
HDMI Out 1	_____	_____	
HDMI Out 2 (AVR 3700/AVR 370 only)	_____	_____	
Composite Video Monitor Out	_____	_____	

Record Output Connector	_____	_____	Connected Device
Analog Audio Rec Out	_____	_____	

Source Buttons and Assigned Connectors

### Connect Your HDMI Devices

If any of your source devices have HDMI connectors, using them will provide the best possible video and audio performance quality. Since the HDMI cable carries both digital video and digital audio signals, you do not have to make any additional audio connections for devices you connect via an HDMI cable.

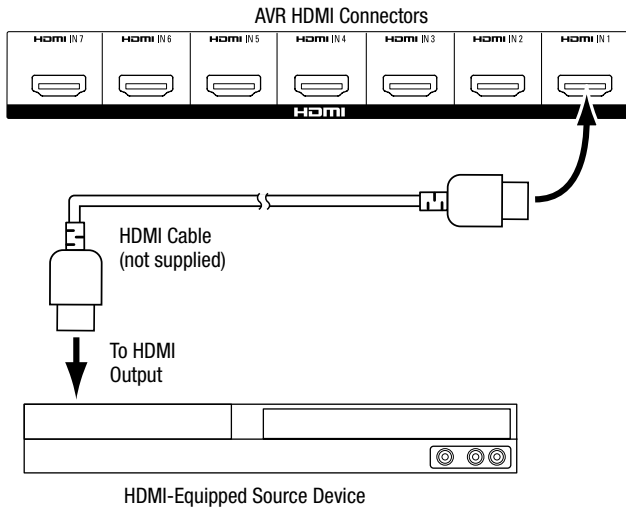

**NOTE:** If you have HDMI devices (such as an Internet connection) already connected directly to your TV, you can feed their sound to the AVR via the HDMI Out connector's Audio Return Channel, and they will not require additional connections to the AVR.

### Connect Your Component Video Devices

If any of your video source devices have component video connectors (and do not have HDMI connectors), using the component video connectors will provide superior video performance. You will also need to make an audio connection from the device to the receiver.

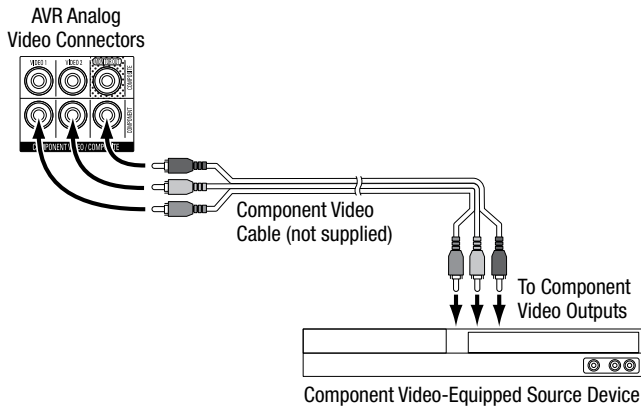

### Connect Your Composite Video Devices

Use composite video connectors for video source devices that don't have HDMI or component video connectors. You will also need to make an audio connection from the source device to the receiver.

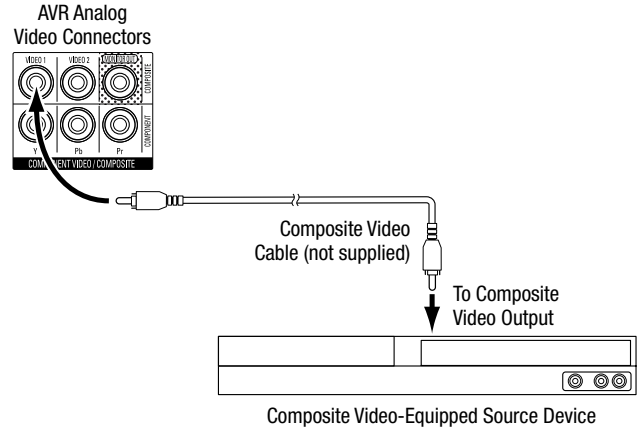

### Connect Your Optical Digital Audio Devices

If your non-HDMI source devices have optical digital outputs, connect them to the AVR's digital digital audio connectors. **NOTE:** Make only one type of digital connection (HDMI, optical or coaxial) from each device.

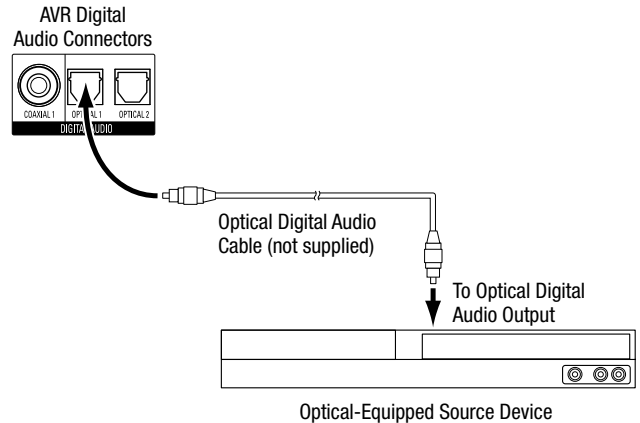

### Connect Your Coaxial Digital Audio Devices

If your non-HDMI source device has a coaxial digital output, connect it to the AVR's coaxial digital audio connector. **NOTE:** Make only one type of digital connection (HDMI, optical or coaxial) from each device.

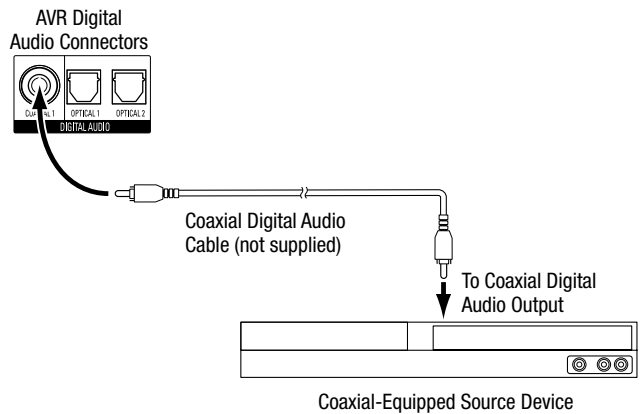

### Connect Your Analog Audio Devices

Use the AVR's analog audio connectors for source devices that don't have HDMI or digital audio connectors. **NOTE:** If you're installing a multizone system, make analog audio connections for any source devices you want to be able to listen to in Zone 2. Only analog sources are available in Zone 2.

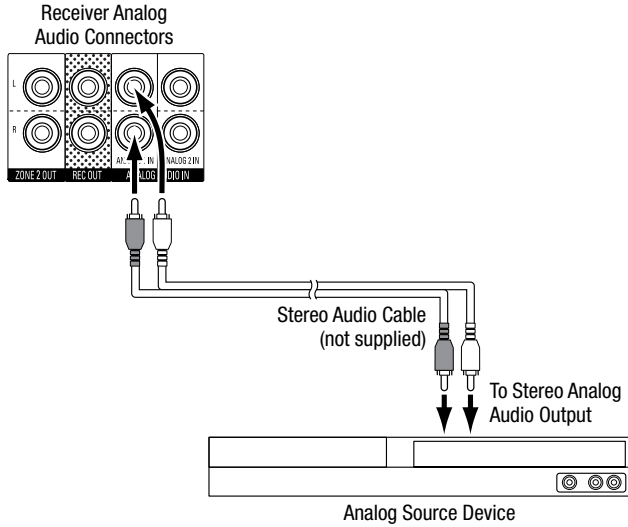

### Connect Your Video Recorder

Connect an analog video recorder's video input connector to the AVR's Composite Monitor Out connector. You can record any composite video signal. To record the audio from the source device, connect the AVR's Analog Rec Out connectors to the analog video recorder's audio inputs. **NOTE:** If you have connected the AVR's Composite Monitor Out video connector to your TV you cannot connect a VCR to the AVR for recording.

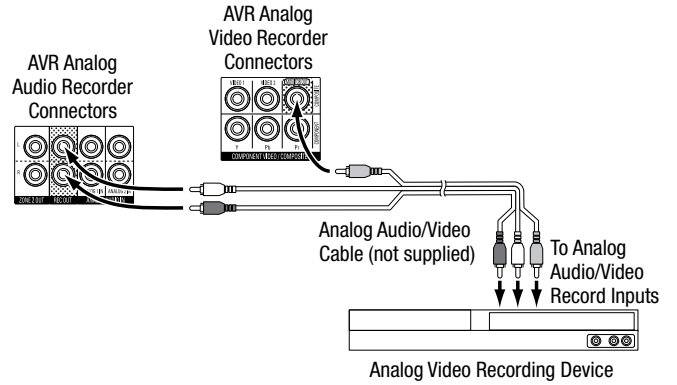

### USB and iOS Devices

Use the AVR's front-panel USB port to connect an iPod, iPhone or iPad using an Apple cable (not supplied) or to directly connect a USB memory stick. You can play audio files from the device or memory stick and use the AVR's remote to control playback.

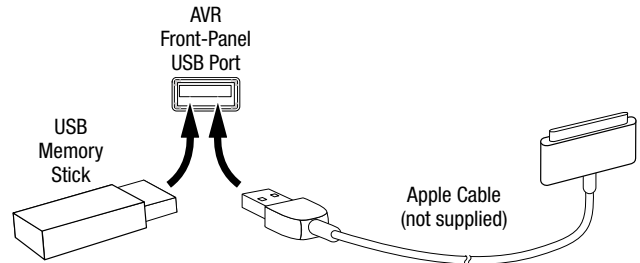

### Connect Your Audio Recorders

Connect an analog audio recorder's inputs to the AVR's analog audio Rec Out connectors. You can record any analog audio input signal.

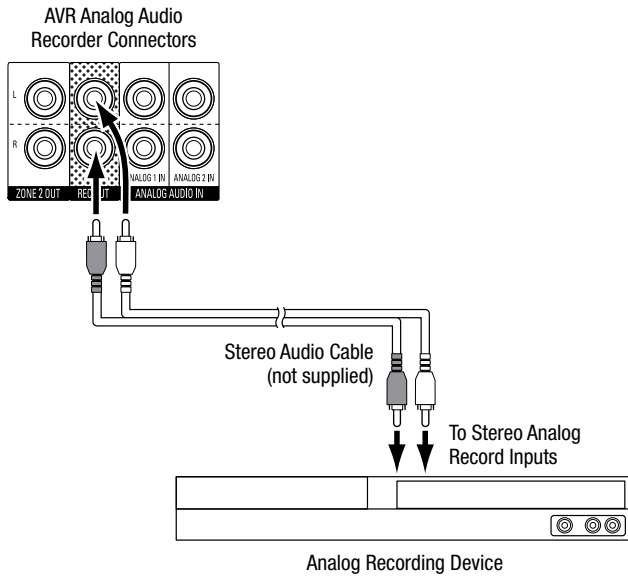

## Connect to Your Home Network

Use a Cat. 5 or Cat. 5E cable (not supplied) to connect the AVR's Network connector to your home network to enjoy Internet radio and content from DLNA-compatible devices that are connected to the network.

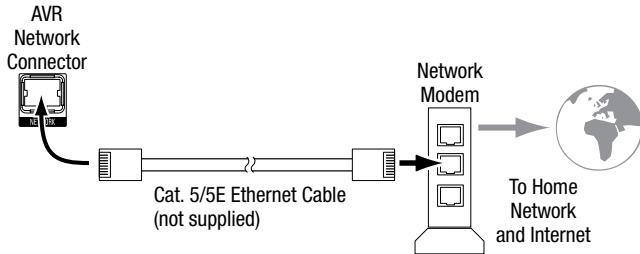

### AVR 3700/AVR 370 only:

If your home network is Wi-Fi®, attach the supplied Wi-Fi antenna to the AVR. You do not need to make a wired network connection.

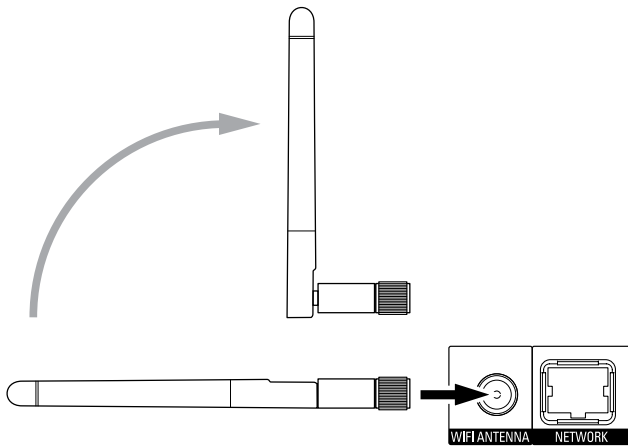

## Connect the Radio Antennas

- Connect the supplied FM antenna to the AVR's FM 75Ω antenna connector. For the best reception, extend the FM antenna as far as possible.
- Bend and fold the base of the supplied AM antenna as shown and connect the antenna wires to the AVR's AM and Gnd connectors. (You can connect either wire to either connector.) Rotate the antenna as necessary to minimize background noise.

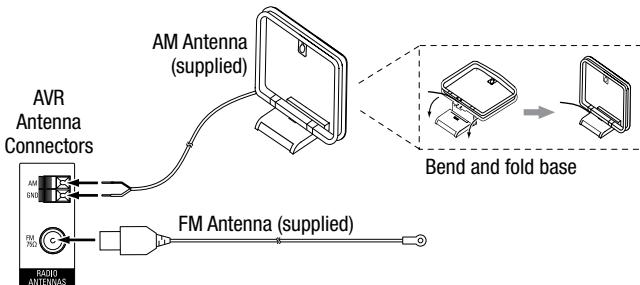

## Install a Multizone System

**IMPORTANT SAFETY NOTE:** Installing a multizone system typically requires running cables inside walls. Always comply with the appropriate safety codes when installing concealed wiring, particularly all applicable building codes. Failure to do so may present a safety hazard. If you have any doubt about your ability to work with electrical wiring, hire a licensed electrician or custom installer to install the multizone system.

**NOTE:** Only the following analog audio sources are available to Zone 2: the internal radio, an iPod/iPhone device or a USB memory device inserted in the AVR's USB port and up to two source devices connected to the rear-panel Analog Audio In 1 and 2 connectors.

Your AVR offers two different methods of distributing audio to other areas in your home. Each requires different connections:

**A. Connect the Zone 2 speakers directly to the Assigned Amp Speaker Output connectors.** Assign the Assigned Amp channels to power the Zone 2 speakers (see *Manual Speaker Setup*, on page 36). This method allows you to power a single pair of speakers for Zone 2.

This method offers the benefit of reduced cost and complexity, but your home theater system will be limited to 5.1 channels – the AVR will automatically downmix the playback of programs recorded in 6.1 or 7.1 channels to 5.1 channels.

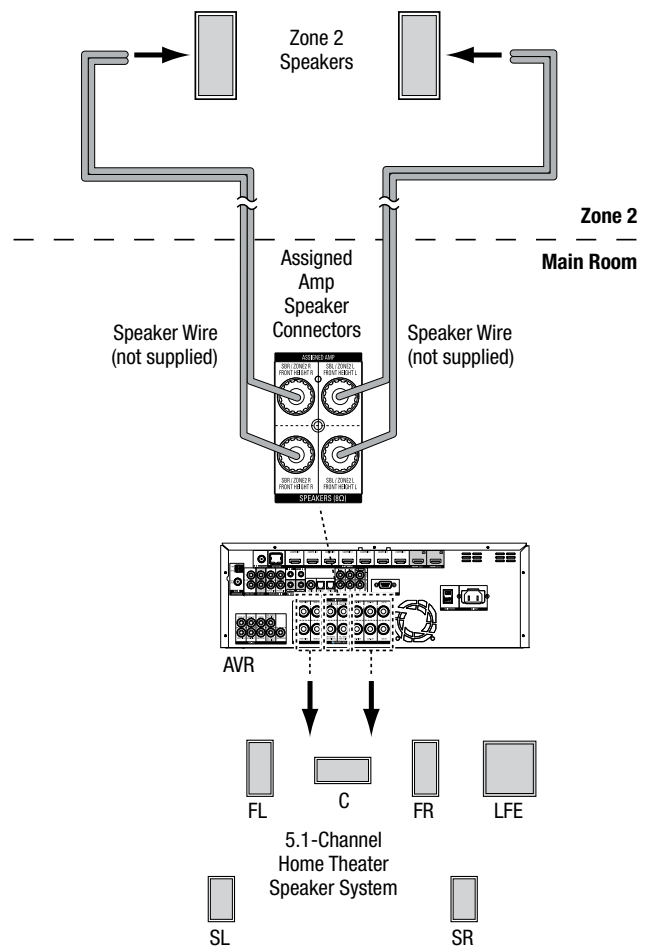

**B. Connect an external amplifier to the AVR's Zone 2 Out connectors.** This method offers the benefit of retaining a 7.1-channel home theater in the main room simultaneously with multizone operation, although it does require an additional amplifier for Zone 2.

We recommend that you place the Zone 2 amplifier in the same room as the AVR so that you can use a short length of stereo audio cable along with a long run of speaker wire to the remote room. A long run of stereo audio cable would increase the chance of signal degradation. Depending on your Zone 2 amplifier you can distribute the audio signal to a single pair of speakers or to several pairs placed in different rooms.

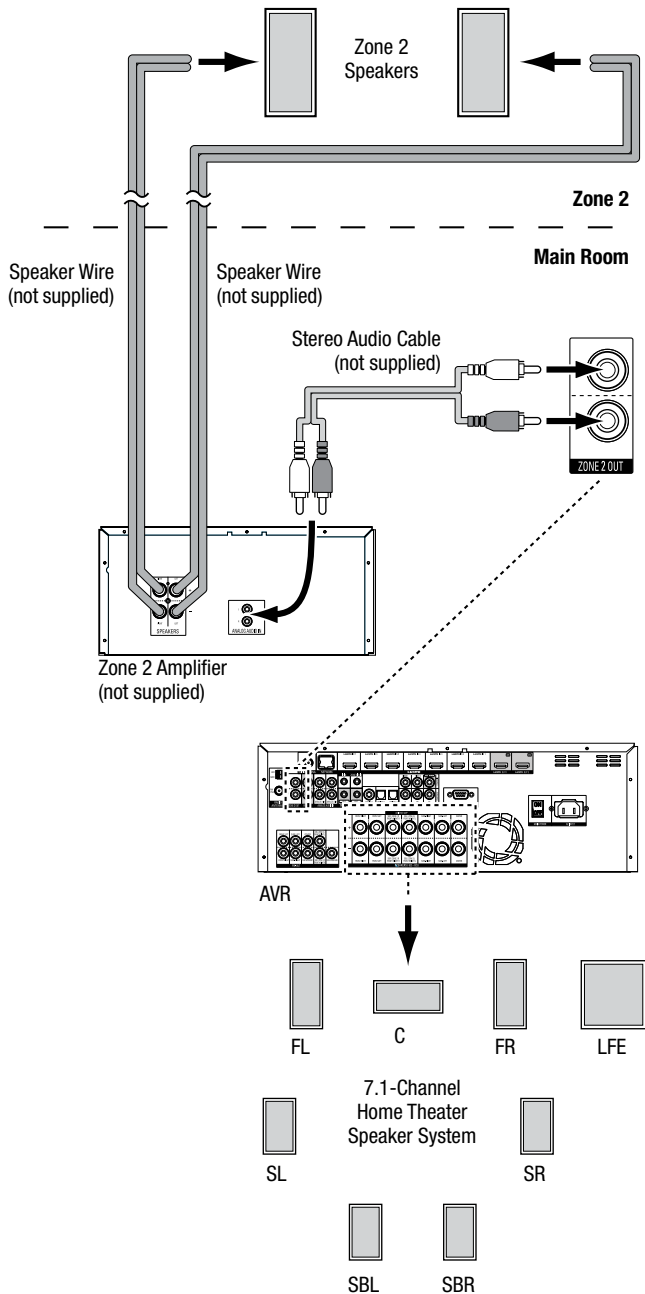

### Connect IR Equipment

The AVR is equipped with Remote IR Input and Output connectors and a Zone 2 IR Input connector that let you remotely control the AVR in a variety of situations:

- When you place the AVR inside a cabinet or facing away from the listener, connect an external IR receiver, such as the optional Harman Kardon HE 1000, to the AVR's IR In jack.

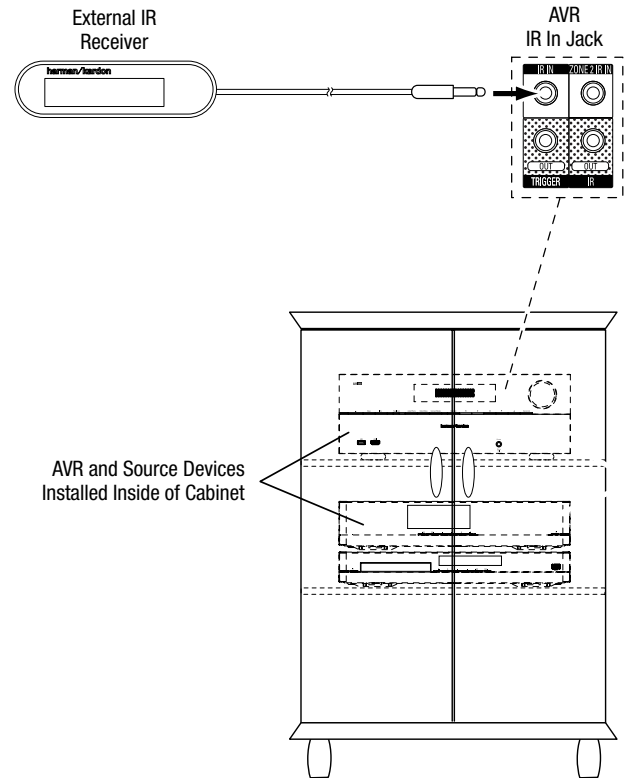

- If any source devices are equipped with a compatible IR input, use a 1/8-inch (3.5mm) mini-plug interconnect cable (not included) to connect the AVR's IR Out jack to the source device's IR input.

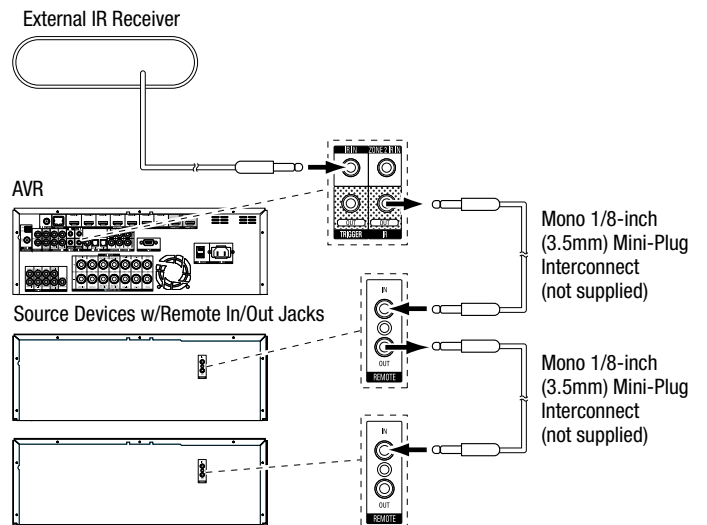

To control more than one source device through the AVR's IR Remote Out connector, connect all sources in "daisy chain" fashion, connecting each device's IR output to the next device's IR input, starting with the AVR.

- If you install a multizone system, connect an IR control device to the Zone 2 IR In connector for remote-room control of the multizone system, source devices and volume in the remote zone.

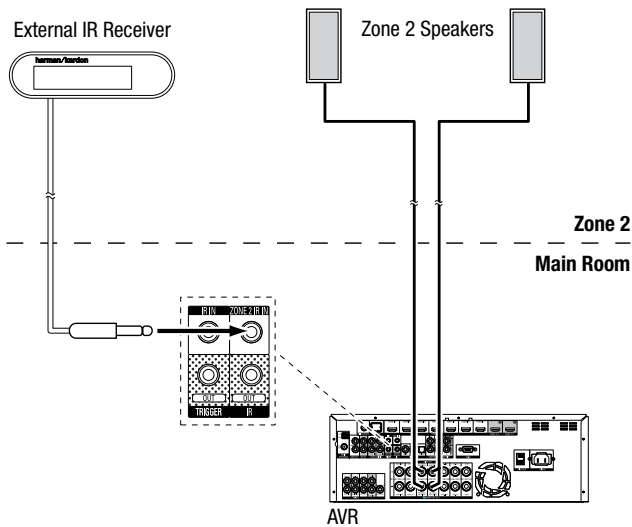

If a source device is shared with the main listening area, any control commands issued to that source will also affect the main room.

### Connect the Trigger Output

If your system has equipment that can be controlled by a DC trigger signal, connect it to the AVR's Trigger Out connector with a mono 1/8-inch (3.5mm) mini-plug interconnect cable. The AVR will supply a 12V DC (100mA) trigger signal at this connection whenever it is powered on.

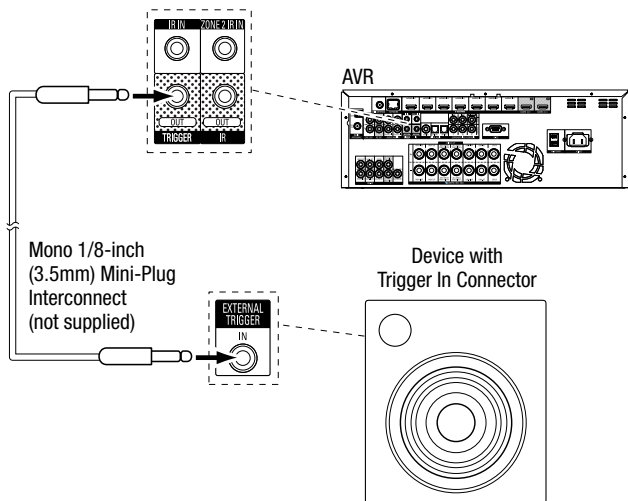

### Connect to AC Power

Connect the supplied AC power cord to the AVR's AC Input connector and then to a working AC power outlet.

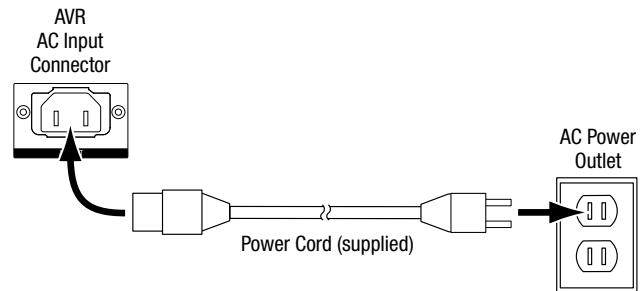

## Set Up the Remote Control

### Install the Batteries in the Remote Control

Remove the remote control's battery cover, insert the four supplied AAA batteries as shown in the illustration, and replace the battery cover.

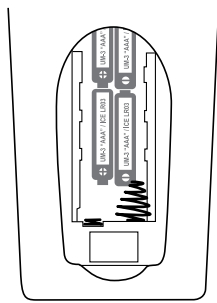

**NOTE:** Remove the protective plastic from the AVR's front panel so it doesn't reduce the remote control's effectiveness.

### Program the Remote to Control Your Source Devices and TV

You can program your AVR remote to control many brands and models of audio/video source devices and TVs. The remote is also ready to operate your iPod or iPhone when it is connected to the AVR's front-panel USB port.

Each of the remote's Source Selector buttons has been preprogrammed to control certain types of source devices:

**Cable/Sat:** Controls cable TV and satellite TV tuner boxes

**Disc:** Controls Blu-ray Disc and DVD players

**Radio:** Controls the AVR's built-in FM/AM tuner

**TV:** Controls TVs and video displays

**USB:** Browses compatible media on an Apple iOS device that is connected to, or a USB device that is inserted in the AVR's USB port. Note: Does not require programming.

**DVR:** Controls TiVo® recorders

**Game:** Controls video-game consoles

**Media Server:** Controls media servers

**Network:** Browses compatible media on DLNA-compatible devices connected to your home network and on vTuner (Internet Radio). Note: Does not require programming.

**AUX:** Controls HDTV tuner boxes, CD players, VCRs and PVDs.

Although the Source Selector buttons are preprogrammed for the device types listed above, you can reassign a Source Selector button to a different device type. See *Reassigning a Source Selector Button for a Different Device Type*, on page 24.

Once you have programmed the remote, you can switch the remote's control mode to access the functions for a particular device by pressing the remote's Source Selector button for that device.

Follow these steps to program the Source Selector buttons for your source devices:

1. Turn on the source device you want to program the remote to control.
2. Look up the code numbers for the device in Tables A14 – A24 in the Appendix. Write all the applicable code numbers in a convenient place.
3. Press the Source Selector button for the device and hold it as it glows red, goes dark and glows red again. Then release it. The remote is now in the Programming mode.

**NOTE:** The remote will remain in the Programming mode for 20 seconds. If you do not complete Step 4 within 20 seconds, the remote will exit the Programming mode, and you will need to repeat Step 3.

4. Aim the remote at the source device and use the remote's Number buttons to enter a code number from Step 1, above.
  - a) If the device turns off, press the Source Selector button again to save the code. The Source Selector button will flash, and the remote will exit the Programming mode.
  - b) If the device does not turn off, enter another code number.
  - c) If you run out of code numbers for a device, you can search through all of the codes in the remote's library for devices of its type by pressing the remote's Up button repeatedly until the device turns off. When it does, press the Source Selector button to save the code.
5. Check that other functions control the device correctly. Sometimes manufacturers use the same Power code for several models, while other function codes vary. Repeat this process until you've programmed a satisfactory code set that operates most of the device's functions.
6. If you searched through the remote's code library to find the code, you can find out which code number you have programmed by pressing and holding the Source Selector button to re-enter the Programming Mode. Then press the remote's OK Button, and the Source Selector button will flash in the code sequence. One flash represents "1," two flashes for "2," and so forth. A series of quick flashes represents "0." Record the code number programmed for each device in Table A9 in the Appendix.

Repeat Steps 3 – 6 for each source device you want to control with the AVR remote.

### Reassigning a Source Selector Button for a Different Device Type

You can reassign a Source Button to control a different device type (for example, you can program the Media Server button to control a DVD player).

1. Turn on the source device you want the remote to control.
2. Look up the code numbers for the device in Tables A14 – A24 in the Appendix. Write all the applicable code numbers in a convenient place.
3. Press the Source Selector button you want to override and hold it for three seconds as it glows red, goes dark and glows red again. Then release it. The remote is now in the Programming mode.
4. Press the Source Selector button that corresponds to the source device's type (i.e., for a DVD player, press the Blu-ray button). The Source Selector button you pressed in Step 3 will flash once.
5. Aim the remote at the source device and use the remote's Number buttons to enter a code number from Step 2, above.
  - a) If the device turns off, press the Source Selector button from Step 3 again to save the code. The Source Selector button will flash, and the remote will exit the Programming mode.
  - b) If the device does not turn off, enter another code number.
  - c) If you run out of code numbers for a device, you can search through all of the codes in the remote's library for devices of its type by pressing the remote's Up button repeatedly until the device turns off. When it does, press the Source Selector button from Step 3 to save the code.

Most of the button labels on the AVR remote describe each button's function when the remote is used to control the AVR. However, the button may perform a different function when used to control another device. Refer to the Remote Control Function List, Table A13 in the Appendix.

You can also program the remote to perform Macros (preprogrammed code sequences that execute many code commands with a single button press), and for "punch-through" programming (allowing the remote to operate a device's channel or transport controls when the remote is in another device's mode). See *Advanced Remote Control Programming*, on page 41, for instructions on these functions.



### Learning (AVR 3700/AVR 370 only)

If you have the device's original remote control, you may "teach" its individual button codes into the following "destination" buttons on the AVR 3700/AVR 370 remote:

Device Power On/Off buttons, Number buttons, Last button, Back/Exit button, Menu button, Up/Down/Left/Right buttons, OK button, Disc Menu button, A/B/C/D buttons, Channel Up/Down buttons, Volume Up/Down buttons, Mute button, Transport Control buttons.

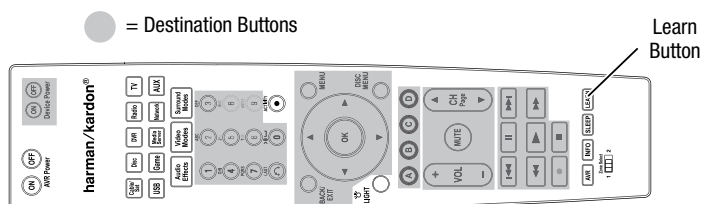

1. Place the two remotes with their IR transmitters facing each other, about 1 inch (25mm) apart.



2. Press the AVR remote's Source Selector button for the source device, then press and hold the Learn button until the Source Selector button glows red. The remote is now in the Learning mode.
3. On the AVR remote, choose a destination button that will learn the source device remote's function. Press the destination button, and the Source Selector will flash once.
4. On the source device's remote, press and hold the button with the function that you want to teach to the AVR remote until the Source Selector button flashes three times. The source device remote's button has now taught the AVR remote's destination button to perform its function on that source.
5. You can program additional buttons for this source by repeating Steps 3 – 4. You can program buttons for other sources by repeating Steps 1 – 4.

When you're finished, press the Learn button once to exit the Learning mode, or wait for the remote to exit the Learning mode on its own after about 30 seconds.

### Set Up the AVR

In this section, you will configure the AVR to match your actual system's makeup. Although it's possible to configure the AVR using only the remote and the messages on the AVR's front-panel display, it is easier if you use the full-screen menu system.

#### Turn On the AVR

1. Set the rear-panel Main Power switch to "On." (The front-panel Power indicator will glow amber.)
2. Press the front-panel Power button.

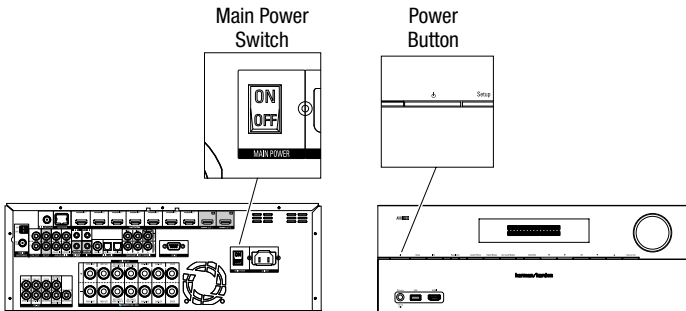

Unless you will not be using the receiver for an extended period of time, leave the Main Power switch set to "On." When the Main Power switch is turned off, any settings you have programmed will be preserved for up to four weeks.

**IMPORTANT NOTE:** If the PROTECT message ever appears in the Message Display, turn off the AVR and unplug it. Check all speaker wires for a short-circuit ("+" and "-" wires touching). If none is found, bring the unit to an authorized Harman Kardon service center for inspection and repair before using it again.

#### Using the On-Screen Menu System

To access the menu system, press the AVR button on the remote or the Setup button on the front panel. The Main Menu will appear, and if a video source is playing, it will be visible behind the menu.

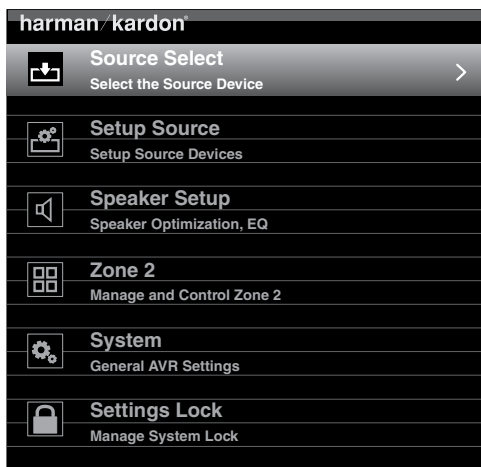

**NOTE:** When you are using the AVR's on-screen menu system, we recommend a video output resolution of 720p or higher for easiest viewing and for graphics that simplify some configuration options. Depending on the resolution selected, the menus shown by your system may vary in appearance from the illustrations.

The Main Menu system consists of six submenus: Source Select, Setup Source, Speaker Setup, Zone 2, System and Settings Lock. Use the Up/Down/Left/Right buttons on the remote or the front panel to navigate the menu system, and press the OK button to select a menu or setting line, or to enter a new setting.

The current menu, setting line or new setting will appear in the front-panel Message Display, as well as on screen.

To return to the previous menu or exit the menu system, press the Back/Exit button. Be certain all settings are correct, as any changes you have made will be retained.

Most users should follow the instructions in this *Set Up the AVR* section to configure a basic home theater system. You may return to these menus at any time to make additional adjustments, such as those described in the *Advanced Functions* section, on page 33.

Before beginning the following setup steps, all loudspeakers, a video display and all source devices should be connected. You should be able to turn on the AVR and view the main menu when you press the AVR button. If necessary, reread the *Making Connections* and *Set Up the Remote* sections before continuing.

#### Configure the AVR for Your Speakers

1. Plug the supplied EzSet/EQ microphone into the AVR's Headphone connector.

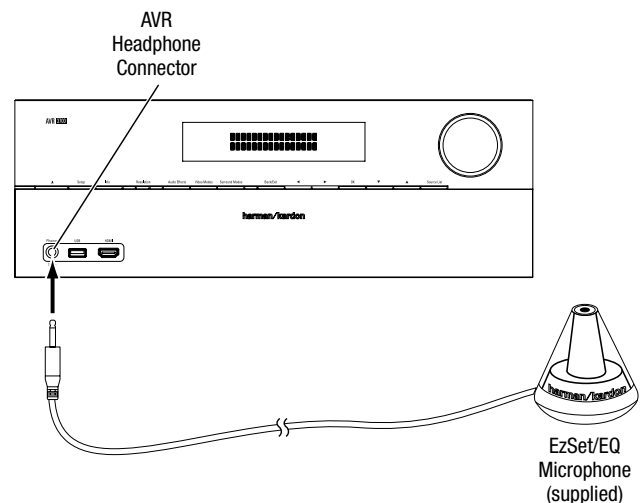

2. Place the microphone at ear height in your listening position. The microphone features a threaded insert on the bottom for mounting on a camera tripod.
3. Set the volume control on your subwoofer to approximately the halfway point.
4. Turn on your TV and select the TV input where you connected the AVR in *Connect Your TV or Video Display*, on page 17.

- Press the remote control's AVR button. The AVR's on-screen display (OSD) Main Menu screen will appear on the TV.



- Use the remote's Up/Down/Left/Right and OK buttons to select "Speaker Setup."

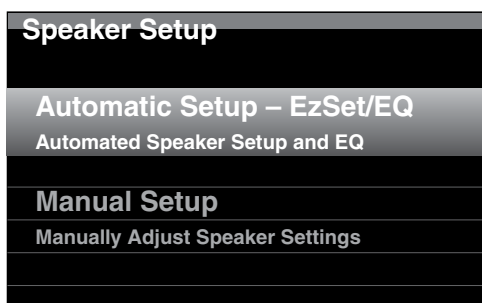

- Select "Automatic Setup - EzSet/EQ" and then select "Continue."
- Select the number of speakers in your system. Select "5.1" if no surround back or front height speakers are present or if you will be using the Assigned Amp channels for multizone operation.
- The test will begin. Make sure that the room is quiet while the test noise is playing through the speakers.
- When the test finishes, select "Continue," then select "View Settings" to see the results of the EzSet/EQ process, or select "Done" to exit.

**NOTES:**

- If there are fewer than five main speakers in your system, do not use the EzSet/EQ process. Instead, proceed as described in *Manual Speaker Setup*, on page 36.
- If you are using a 6.1-channel configuration with a single surround back speaker, use EzSet/EQ automatic configuration for 5.1 speakers, connect the single surround back speaker to the left Assigned Amp Speaker Output connector, then configure the surround back speaker manually, as described in *Manual Speaker Setup*, on page 36.

## Set Up Your Sources

The Setup Source menu lets you assign the correct physical audio and video connections to each source and lets you set many audio and video playback features for each source. **IMPORTANT: The "Video Input from Source," "Audio Input from Source" and "Resolution to Display" settings are not optional and must be adjusted before you use your AVR to enable playback of each source.** You can adjust the other settings later. See *System Settings*, on page 39, for complete information about adjusting all of the Settings menu options.

- Review the assigned connectors you listed on the *Source Buttons and Assigned Connectors* table, on page 18. Note what changes (if any) you want to make from the default source-button connector assignments that appear on the list. (If there are no changes, you can skip this section.)
- To display the Source Settings menu for the active source, press the Info button on the front panel or remote. Or, from the Main Menu screen, select "Setup Source" and select a source from the slide-in menu. The Settings menu for that source will appear.

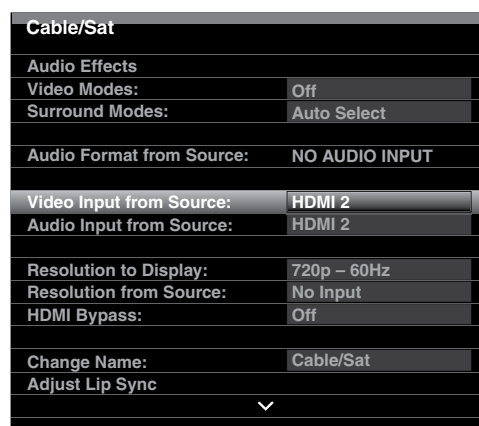

- Select "Video Input From Source" and select the video input connector you want to assign to the source button. Press the OK button. NOTE: If you select an HDMI connector as the Video Input from Source, the Audio Input from Source will automatically change to the same HDMI connector. If you want to use a different audio connection, proceed to step 4.

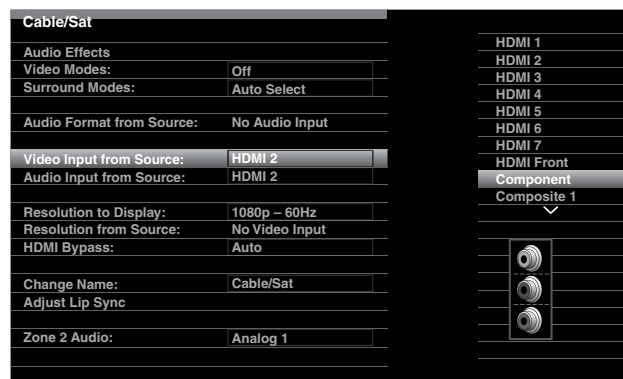

- Select "Audio Input from Source" and select the audio input connector you want to assign to the source button. Press the OK button.

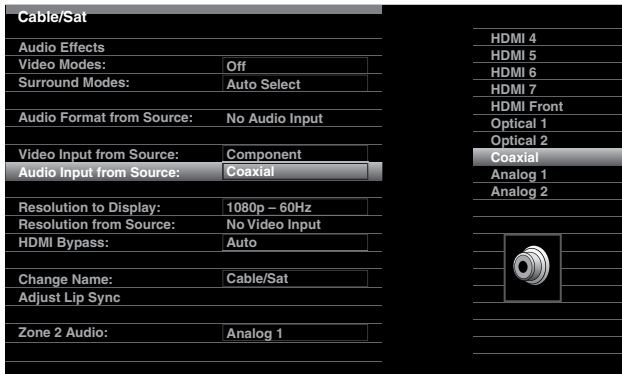

**Resolution to Display:** This setting reflects the video output resolution, which is dependent upon the capabilities of your TV or video display.

- If you connected your TV to the AVR's HDMI Monitor Out connector, the two devices will communicate with each other, and the AVR will automatically select the best available video output resolution. In almost all cases, you should leave the resolution set to the AVR's automatic selection. (You can override this automatic selection if your video display's native resolution is different from the AVR's automatic selection.)
- If you connected your TV to the AVR's Composite Video Monitor Out connector, you *must* set the resolution to "480i" (AVR 3700/AVR 2700) or to "576p" (AVR 370/AVR 270) to view any content.

**NOTE:** If your connected TV is 4K video capable, the AVR will automatically pass 4K video sources through to the TV in their native resolution and will upscale non-4K video sources up to 4K.

**Audio Effects:** This submenu allows you to adjust the Dolby Volume and Dolby PLII/IIx/IIz settings, the bass and treble tone controls, the LFE trim and the Equalization On/Off setting for each source independently. We suggest leaving this submenu at its default settings and returning to it later if your system requires fine-tuning. See *Audio Effects Button*, on page 34, for more information.

**Video Modes:** This submenu allows you to make picture adjustments for each source independently. We suggest leaving the settings at their factory defaults. You should make picture adjustments to your video display first and use this menu only for fine-tuning. See *Video Processing*, on page 34, for more information.

**Surround Modes:** This submenu lets you program surround modes for movies, music and games for each source independently. Digital surround signals, such as Dolby Digital and DTS bitstreams, are automatically played in their native formats, although you may change the surround mode. See *Audio Processing and Surround Sound*, on page 33, for more information.

**Audio Format from Source:** This line is informational only. When a digital program is playing, its format will be identified here. When analog audio programs are playing, this line displays ANALOG.

**Resolution from Source:** This line is informational only. It indicates the resolution of the video output by the source device.

**HDMI Bypass:** This setting allows you to bypass the AVR's internal video processing for proper display of 3D video content and of source devices (such as some game consoles) where the AVR's video processing can create delays that can cause synchronization errors between the sound and picture. There are two available settings:

- On: Always bypasses the AVR's internal video processing.
- Auto: Automatically bypasses the AVR's internal video processing when 3D content is detected.

**IMPORTANT:** Once the AVR automatically switches into the bypass mode upon detecting 3D video content, it will not automatically switch out of the bypass mode when it detects conventional 2D video content. To turn the HDMI Bypass off you must cycle the AVR into the Standby mode and then turn it on again.

We suggest that you create an additional source configuration for each of your 3D video source devices by assigning each an unused Source Selector button on the AVR's remote control. For example, you can assign the AVR's "Media Server" source as the 3D source for a 3D-capable disc player or game, and you can assign one of the AVR's "A/B/C/D" source buttons as the 3D source for your cable or satellite tuner's 3D programming.

### Creating "HDMI Bypass" Inputs

In this example, we will program the Media Server source as an HDMI Bypass source for 3D programming:

- Select "Setup Source." The source list will appear.
- Select "Media Server." The Media Server setup screen will appear.
- Select "HDMI Bypass." A confirmation screen will appear.
- Select "OK." The AVR will exit the menu mode.

Repeat Steps 1 – 4, assigning a new 3D source for each of your 3D-capable source devices.

#### Notes:

- When using your AVR with these new settings, be sure to press the correct source selectors for your 2D and 3D sources.
- If you are viewing 3D sources when an HDMI Bypass input is active, the on-screen indications for volume level will not appear. This is normal, since all video processing is removed in the HDMI Bypass mode.
- If your video sources are always operating at 720p or higher resolution, you may find the HDMI Bypass mode acceptable for normal 2D viewing as well as for 3D viewing. In this case, you may find it more convenient to use the 3D sources at all times.
- If you see side-by-side or top-and-bottom images while watching a 3D program, manually switch to the HDMI Bypass mode.

**Change Name:** This selection lets you change the display name for the source, which is useful if your source's device type is different from the source's preprogrammed name. Select this line and use the Up/Down buttons to scroll forward or reverse through the alphanumeric characters. When the desired character appears, use the Left/Right buttons to move the cursor to the next or previous position. Move the cursor again to leave a blank space. When you have finished, press the OK Button. The name will appear on the AVR's front panel and throughout the on-screen menu system.

**Adjust Lip Sync:** This selection lets you resynchronize the audio and video signals from a source to eliminate a "lip sync" problem. Lip-sync issues can occur when the video portion of a signal undergoes additional processing in either the source device or the video display. When you make a Lip Sync adjustment, the Lip Sync menu appears by itself, enabling you to view the video while listening to the audio. Use the Left/Right buttons to delay the audio by up to 180ms.



**Zone 2 Audio:** This setting determines the audio source for Zone 2 of a multizone system. Select the analog audio input the source is connected to. Digital audio is not available to the multizone system.

To configure the next source, press the Back/Exit button, then return to the Setup Source line of the Main Menu. When you have finished configuring all sources, press the Back/Exit button to clear the menus from view.

### Set Up the Network

To play MP3 or WMA media located on DLNA-compatible devices connected to the network, use the AVR's internal Internet radio tuner or listen to sources via AirPlay, the AVR must be connected to your home network and you must join them with the network. (If your home network is Wi-Fi, the AVR 3700 and AVR 370 can connect to it wirelessly.)

### Wired Network Setup

If your network uses an automatic IP address, you should not have to perform any network setup procedures for a wired network connection. Once you connect the AVR to your home network, the network should automatically assign the AVR an IP address, and the AVR should automatically connect to your network.

If your AVR does not automatically connect to your network (in which case the AVR will display a “Not Connected” message when you press the Network source button):

1. Press the AVR button, select System, then select Network Settings. The Wired/Wireless selection screen will appear.
2. Select Wired. The Wired Network Settings menu will appear.

Network Settings	
Mac	0x:00:0x:00:0x:0x
<b>Network Settings:</b>	<b>Automatic</b>
IP Address:	000 . 000 . 000 . 000
Subnet Mask:	000 . 000 . 000 . 000
Gateway:	000 . 000 . 000 . 000
Primary DNS:	000 . 000 . 000 . 000
Secondary DNS:	000 . 000 . 000 . 000
Proxy	Off
IP Address:	000.000.000.000
Proxy Port:	00000
<b>Network Status:</b>	<b>Connected</b>
<b>Apply &amp; Save</b>	

3. Select Network Settings, the press the OK button twice to cycle the setting from “Automatic” to “Manual” and back to “Automatic.”
4. Select Apply & Save. The AVR will attempt to connect to the network.
5. If the AVR again fails to connect to the network, you may need to enter your network’s settings manually. See *Network Settings* (under *General AVR Settings*), on page 40, for complete instructions. You may need to obtain your network’s settings from your ISP or network administrator.

**NOTE:** We recommend that you directly connect the AVR to a home-network router so that it can directly access the Internet for Internet radio, or access a PC on the network for playback of content stored on the PC (see *Listening to Media via Your Home Network*, on page 32, for more information).

### Wireless Network Setup (AVR 3700/AVR 370)

If you want to join the AVR to your Wi-Fi network you will need to perform the following setup procedure.

1. Press the AVR button, select System, then select Network Settings. The Wired/Wireless/ Network Upgrade selection screen will appear.
2. Select Wireless. The Wireless Network Settings menu will appear.

Network Settings	
<b>Search AP</b>	
Information	
iPod Network Setup	
AVR AP Mode	

The following options appear in the Wireless Setup menu:

- **Search AP:** Select this option to display and select the wireless network you wish to join.
- **Information:** Select this option to display the settings information for the active wireless network. This screen is informational only – you cannot make changes in the network settings from it.
- **iPod Network Setup:** Selecting this option lets you use your portable device with iOS 5 or later to automatically have the AVR join the same wireless network to which the device is already connected. See *Using your iOS 5 device to join the wireless network*, below, for details.
- **AVR AP Mode:** This option provides an alternate method for connecting to a wireless network without using the AVR’s on-screen display.

**NOTE:** If you have already made a connection to a wired network you will not be able to select the Wireless setting. Disconnect the AVR from the wired network and begin again at Step 1.

3. Select Search AP and select the network you wish to join from the ones displayed. The Enter Password screen will appear.
4. Use the remote’s up and down arrow buttons to select each character in your Wi-Fi network’s password. (The characters will appear on the AVR’s front-panel display and the OSD screen.) When you have selected the correct character, use the right arrow button to move to the next one. If you make a mistake, use the left arrow button to change a previous character.
5. Once the correct password is displayed on the AVR’s front-panel display and the OSD screen, press the OK button. The AVR will attempt to join the network.
6. When the AVR has successfully joined the network it will display “Connection Success” on its front-panel display and OSD.
  - If the AVR is not able to join the network it will display “Connection Failure.” If this happens, confirm that you entered the correct password, attempt to connect to another wireless network or make a wired network connection.

### Using your iOS 5 device to join the wireless network:

1. Make sure that your iOS 5 device is joined with the wireless network you want the AVR to join.
2. Connect your iOS 5 device to the AVR’s front-panel USB port.
3. The iPod Network Setup option described in Step 2, above, will become available. Select it.
4. The AVR will automatically join the network without requiring further input from you.

## Operating Your AVR

Now that you have installed your components and completed a basic configuration, you are ready to begin enjoying your home theater system.

### HARMAN AVR App

For easy control of your AVR with your hand-held device, download the free Harman Kardon AVR app from iTunes App Store for compatible Apple products, or from Google Play for compatible Android powered smartphones and tablets.

The Harman Kardon AVR App controls virtually all the functions of AVR 3700, AVR 370, AVR 2700 and AVR 270 receivers that are connected to the same network as the device that has the app installed. With this easy-to-use app you can turn the AVR on or off, select a source, control the volume and virtually any other function. You can also access and navigate all of the AVR's on-screen setup menus.

### Controlling the Volume

Adjust the volume either by turning the front-panel Volume knob (clockwise to increase volume or counterclockwise to decrease volume) or by pressing the Volume Up/Down buttons on the remote. The volume is displayed as a negative number of decibels (dB) below the 0dB reference point (-90dB – +10dB).

0dB is the maximum recommended volume for your AVR. Although it's possible to turn the volume to a higher level, doing so may damage your hearing and your speakers. For certain more dynamic audio materials, even 0dB may be too high, allowing for damage to equipment. Use caution with regard to volume levels.

To change the volume level display from the default decibel scale to a 0-to-90 scale, adjust the Volume Units setting in the System Settings menu, as described in *System Settings*, on page 39.

### Muting the Sound

To mute all speakers and the headphones, press the Mute button on the remote. Any recording in progress will not be affected. The MUTE message will appear in the display as a reminder. To restore the sound, press the Mute button again, or adjust the volume.

### Dolby Volume

Your AVR implements Dolby Volume processing, which can improve the audio performance of the system by revealing subtle details in the sound, even at normal home-listening volumes.

One concern of the typical home theater listener is that volumes can vary widely for different programs played by a source (e.g., television commercial advertisements are often much louder than the main program). Another is that details heard in the recording studio at typically high reference volumes are lost at the lower volumes used by many listeners at home.

The AVR uses two Dolby Volume techniques to address these issues. The Leveler module maintains a consistent listening volume within a source (e.g., commercial television or different tracks on a USB drive or mix CD). The Modeler module endeavors to re-create the reference presentation that was heard in the recording studio without losing portions of the program at the typically lower volume levels often used in the home. When the Modeler module is active, you may notice details of the performance that were hidden when the program was played on other equipment.

To adjust the Dolby Volume setting, press the Audio Effects button. The Audio Effects submenu will appear.

After you highlight the Dolby Volume setting, each press of the OK button will switch to one of the options in the table below. The settings do not refer to the volume level, which is adjusted normally using the AVR's Volume Control, but rather to the amount of Dolby Volume processing desired.

Setting	Effect
Off	No Dolby Volume processing
Low	Only Dolby Volume Modeler module is active
Medium	Both Modeler and Leveler modules are active; Leveler module has a value of 3
Max	Both Modeler and Leveler modules are active; Leveler module has a value of 9

**NOTE:** Dolby Volume processing is compatible with sources recorded at a sampling rate of 48kHz. High-resolution sources, such as DTS 96/24 programs, will be decoded at 48kHz. DTS 96/24 programs will be played in DTS 5.1 mode. To hear DTS 96/24 materials in high resolution, turn off Dolby Volume processing.

### Dolby Volume Calibration

Dolby Volume calibration allows you to adjust the operation of the Dolby Volume circuitry to match your particular speakers and listening environment. The Dolby Volume circuitry in your AVR is factory-calibrated with average speaker sensitivity in mind; however, different speakers may have different sensitivities, which will affect the overall performance of the Dolby Volume circuitry. Use Dolby Volume calibration to adjust the calibration of the circuitry according to the specific speakers you have.

The average home audio speaker sensitivity is 88dB SPL (1 watt/1 meter). Check the sensitivity specification for your loudspeakers, found in the owner's manual or on the manufacturer's Web site. If your speakers have a sensitivity rating greater than 88dB SPL, increase Dolby Volume calibration by the difference between your speakers' sensitivity and 88dB. If they have a sensitivity rating of less than 88dB SPL, decrease Dolby Volume calibration by the difference between your speakers' sensitivity and 88dB.

To adjust the Dolby Volume calibration, press the AVR button and select the "System" menu. Scroll to the Dolby Volume calibration line, which defaults to 0dB. Use the Left/Right buttons to adjust the setting within the range of -10dB to +10dB.

### Listening Through Headphones

Plug the 1/4-inch stereo plug on a pair of headphones into the front-panel Phones jack for private listening. The default Headphone Bypass mode delivers a conventional two-channel signal to the headphones. Press the Surround Modes button on the front panel or the remote to switch to HARMAN headphone virtual surround processing, which emulates a 5.1-channel speaker system. No other surround modes are available for the headphones.

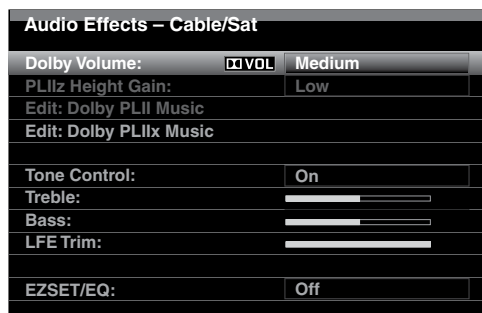

## Selecting a Source

There are three different ways to select a source:

- Press the front-panel Source List button. Use the Up/Down buttons to scroll through the sources, and press the OK button to select the source being displayed.
- Using the on-screen menus, press the AVR button, highlight "Source Select" and press the OK button. Scroll to the desired source in the slide-in menu and press the OK button.
- You can directly select any source by pressing its Source Selector button on the remote.

The AVR selects the audio and video inputs assigned to the source, and any other settings you made during setup.

The source name, the audio and video inputs assigned to the source, and the surround mode will appear on the front panel. The source name and active surround mode will also briefly appear on the TV screen.

### Video Troubleshooting Tips

If there is no picture:

- Check the source selection and video input assignment.
- Check all connections for a loose or incorrect connection.
- Check the video input selection on the TV/display device.
- Press the front-panel Resolution button and use the Up/Down buttons until the correct video output resolution is selected and a picture appears. The CANCEL message will also appear. Press the Down button to view the ACCEPT option, then press the OK button.

### Additional Tips for Troubleshooting HDMI Connections

- Turn off all devices (including the TV, the AVR and any source components).
- Unplug the HDMI cables, starting with the cable between the AVR and the TV, and continuing with the cables between the AVR and each source device.
- Carefully reconnect the cables from the source devices to the AVR. Connect the cable from the AVR to the TV last.
- Turn on the devices in this order: TV, AVR, source devices.

**NOTE:** Depending upon the particular components involved, the complexity of the required communication between HDMI components may cause delays of up to a minute in the completion of some actions, such as input switching or switching between SD and HD channels.

## Listening to FM and AM Radio

Select the Radio source. A screen similar to the one in the illustration below will appear.



Use the Up/Down buttons or the Remote's Channel buttons to tune a station as displayed on the front panel and on-screen display.

The AVR defaults to automatic tuning, meaning each press of the Up/Down buttons scans up or down the frequency band until a station with acceptable signal strength is found. To switch to manual tuning, in which each press of the Up/Down buttons steps through a single tuning frequency increment, press the remote's Menu button. A slide-in menu will appear. Select "Mode," and press the OK button to toggle between automatic and manual tuning modes.

Once you have tuned an FM station, toggling the Mode setting also switches the radio between stereo and monaural reception. (Mono reception may improve reception of weaker stations.)

### Preset Stations

You can store a total of 30 stations (AM and FM combined) as presets. When you want to save the currently tuned station as a preset, press the OK button, and two dashes will flash. Use the Number buttons to enter the desired preset number.

To tune to a preset station:

- Press the Left/Right buttons.
- Press the skip forward/skip backward Transport Control buttons.
- Press the Menu button and scroll to the desired preset, then press the OK button.
- Enter the preset number using the Number buttons. For presets 10 through 30, press 0 before the preset number. For example, to enter preset 21, press 0-2-1.

## Listening to Media on a USB Device

Your AVR is compatible with MP3 and WMA media.

**MP3 compatibility:** Mono or stereo, constant bit rates (CBR) from 8kbps to 320kbps, variable bit rates (VBR) from lowest to highest quality, with sample rates from 8kHz – 48kHz.

**WMA compatibility:** Ver. 9.2, stereo CBR with 32kHz – 48kHz sampling rate and 40kbps – 192kbps bit rate, mono CBR with 8kHz – 16kHz sampling rate and 5kbps – 16kbps bit rate, VBR Pass Encoding and Quality Encoding 10 – 98, 44kHz and 48kHz sampling rate.

No other types of media can be played.

## Playing files on a USB device

1. Insert the USB drive into the AVR's front-panel USB port.

**IMPORTANT:** Do not connect a personal computer or peripheral to the USB port. USB hubs and multi-card readers are not supported.

2. Select the USB Source Selector button on the remote. "USB" will appear on the front-panel display, and the USB screen and the slide-in menu will appear.

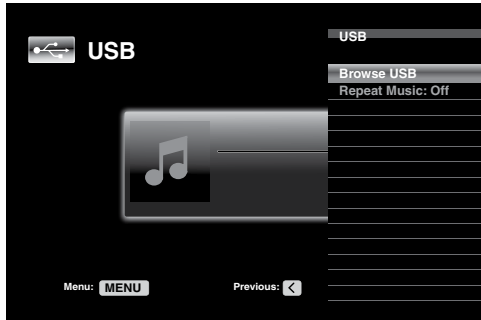

3. Select "Browse USB." The AVR will list the folders located on the drive.

4. Select a folder and press the OK button. The AVR will list all compatible audio files.

5. Select a file to begin playback. The USB play screen will appear. Any ID3 information and album art will be displayed, along with the track's elapsed/current time and icons indicating the current playback status.

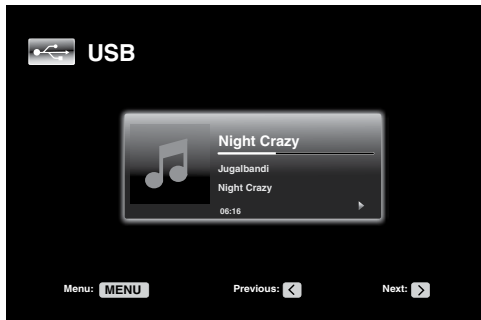

### NOTES:

- To skip to the next track, press the Right button; to return to the previous track, press the Left button once.
- You can use the Transport Control buttons to control playback (skipping to the previous or next track, searching at high speed forward or backward within a track, playing a file, pausing playback or stopping playback).
- To repeat a file or folder, press the Menu Button and select the Repeat option. Each press of the OK Button will change the setting from Off (no repeat) to Repeat One (file) to Repeat All (files at the current directory level of the drive). Repeat All will always be activated when Random Music playback is turned on.
- To play the audio tracks in random order, press the Menu button and select the Random Music setting. Each press of the OK button turns the setting on or off. The AVR will automatically repeat the tracks until playback is stopped manually.
- To collapse a folder or return to the previous menu level, press the Back/Exit button or the Left button.

## Listening to an iPod/iPhone/iPad Device

When an iPod, iPhone or iPad device is connected to the AVR's front-panel USB port, you may play audio files through your high-quality audio system, operate the iPod, iPad or iPhone using the AVR remote or the AVR's front-panel controls, view navigation messages on the AVR's front panel or a connected video display and charge the iPod, iPad or iPhone. For the latest compatibility information, please see our Web site: [www.harmanardon.com](http://www.harmanardon.com).

Press the USB source selector button on the remote until the front-panel display's "iPod" as the source. The iPod screen will appear and the slide-in menu will automatically appear.

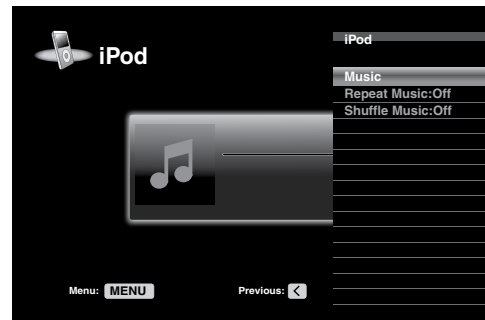

The table below summarizes the controls available during normal playback via the USB port.

iPod or iPhone Function	Remote Control Key
Play	Play
Pause	Pause
Menu	Menu
Back/Exit	Back/Exit or Left Arrow
Select	OK or Right Arrow
Scroll Reverse	Up Arrow
Scroll Forward	Down Arrow
Forward Search	Forward Search
Reverse Search	Reverse Search
Next Track	Skip Forward or Right Arrow
Previous Track	Skip Backward or Left Arrow
Page Up/Down	Page Up/Down

While scrolling, hold the button to scroll faster. Use the Page Up/Down control on the remote to scroll a page at a time.

While a selection is playing, the album, artist, song title, track elapsed time, total track time and play mode icon will appear on the front-panel Message display.



If a video monitor is connected to the AVR and the system is not in iPod manual mode, an iPod screen will appear and display the play mode icon, song title, artist and album. A graphic bar indicates the current play position within the track. If random or repeat play has been programmed, an icon will appear in the upper right corner.

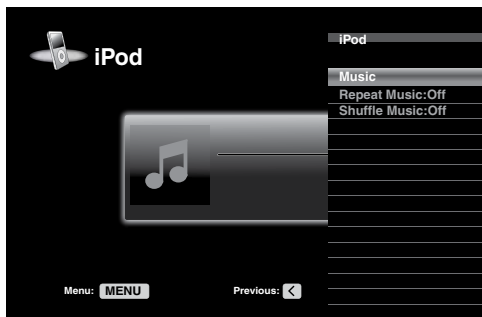

The screen may disappear from view, depending on the Setup and Slide-In Menus setting in the System Settings menu (described in *System Settings*, on page 39). You can restore the Now Playing screen to view by pressing either of the Left or Right buttons.

**CAUTION:** We strongly recommend that you use the screen saver built into your video display to avoid possible damage from “burn-in” that may occur with plasma and many CRT displays when a still image, such as a menu screen, remains on the display for an extended period of time.

Press the Menu button to view the slide-out menu:

**Music:** Select this to navigate the audio materials stored on the iPod, iPad or iPhone. Use the Page up/down buttons on the remote to scroll through the content a page at a time. NOTE: You can only play audio content via the USB port.

**Repeat Music:** Select this setting to repeat a track or all tracks in the current album or playlist. Each press of the OK button switches the setting: repeat Off, repeat One or repeat All.

**Shuffle Music:** Select this setting to play all the available songs in random order. Each press of the OK button switches the setting: shuffle by Song, shuffle by Album, or Off to end shuffle playback.

**NOTE:** The iTunes application allows you to exempt some tracks from Shuffle mode. The AVR cannot override this setting.

## Listening to vTuner (Internet Radio)

Your AVR's Network connection brings you a world of MP3- and WMA-format streams via the Internet. After you have successfully connected to your home network as described in *Connect to Your Home Network*, on page 20, and set up the network as described in *Set Up the Network*, on page 27, press the Network Source Selector button on the remote. Each press toggles between the Network and vTuner screens.

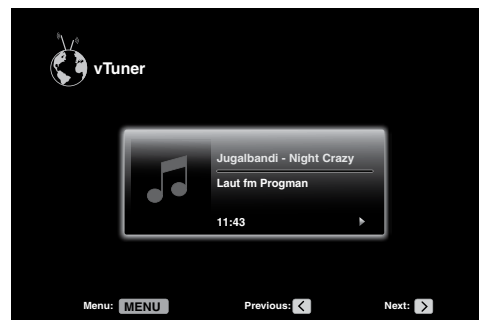

With the vTuner screen (above) displayed, the AVR will automatically connect to the Internet via the [www.radioharmankardon.com](http://www.radioharmankardon.com) portal. To select a stream, press the Menu button, and use the Up/Down buttons to search by category: Presets, My Favourites, Added Stations, Location, Genre, Podcasts by Location, Podcasts by Genre, New Stations, Most Popular Stations, Recently Played and Search. **NOTE:** The categories displayed may vary by region.

To create a Favourites list, log onto [www.radioharmankardon.com](http://www.radioharmankardon.com) from your computer. Enter your AVR's Mac address as its ID # (the Mac address is on the Network Settings screen in the System Settings menu) and create an account. Favourites that you select on the Web site will be available on the AVR.

Navigation is similar to other slide-in menus. Scroll to the desired item and press the OK button to select it. To return to the previous menu level (or to clear the top-level menu from view), press the Back/Exit button or the Left button.

If you know the URL (Web address) of a specific audio stream, select the Direct Station option from the menu. A live stream is required. The AVR is not able to connect to streams that require site registration or other interaction prior to playing the stream. If the AVR cannot connect to the stream, a “Station Not Live” message will appear briefly, and the Internet Radio screen will remain essentially blank. Not all URLs will be accessible.

## Listening to Media via Your Home Network

Your AVR is DLNA-compatible and can access MP3 and WMA audio media that is stored on other DLNA-compatible devices that are connected to the same network as your AVR.

DLNA is a file sharing protocol that creates a bridge between the AVR and other devices on the same network that contain audio media. DLNA is supported by PCs that have Windows Media Player, Windows Media Center or Intel Media Server file sharing. Apple computers can also share files via DLNA using HARMAN Music Manager software, which can be downloaded without charge from [www.harmankardon.com](http://www.harmankardon.com). (Third-party software that enables DLNA file-sharing also is available.)

**MP3 compatibility:** Mono or stereo, constant bit rates (CBR) from 8kbps to 320kbps, variable bit rates (VBR) from lowest to highest quality, with sample rates from 8kHz – 48kHz.

**WMA compatibility:** Ver. 9.2, stereo CBR with 32kHz – 48kHz sampling rate and 40kbps – 192kbps bit rate, mono CBR with 8kHz – 16kHz sampling rate and 5kbps – 16kbps bit rate, VBR Pass Encoding and Quality Encoding 10 – 98, 44kHz and 48kHz sampling rate.

Before you can access files located on other devices via the network, each device must first give permission to share files with the AVR:

### To share media on PCs:

1. Open Windows Media Player.
2. Open the Library menu and select Media Sharing. The Media Sharing window will appear.
3. Check the "Share My Media" box. An icon for the AVR will appear in the window.
4. Select the AVR icon, select "Allow," then select "OK."

The computer's WMA and MP3 media should now be available to the AVR.

To share media on other types of computers, operating systems or media software: Check the instructions for the computer, operating system or media player.

To listen to shared media, press the Network Source Selector button. (If vTuner appears as the source, press the button a second time to switch from the Internet Radio source to the Network source.) The Network screen will appear.

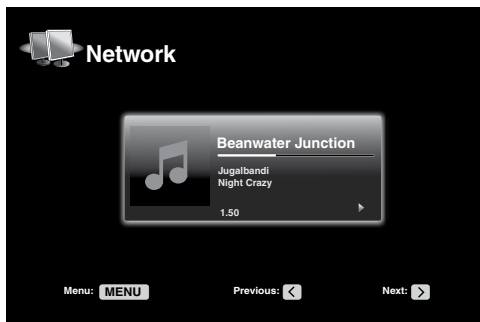

Press the Menu button, and the slide-in menu should list by name all devices that allow sharing. Use the slide-in menu to browse the content stored in the device's media player library. Scroll to the desired item and press the OK button to select it. To return to the previous menu level (or to clear the menu from view from the top level), press the Back/Exit button or the Left button.

NOTE: Although video content may appear in the menu, the AVR does not support video playback from the network connection.

### Selecting a Surround Mode

Selecting a surround mode can be as simple or sophisticated as your individual system and tastes. Feel free to experiment, and you may find a few favorites for certain sources or program types. You can find more detailed information on surround modes in *Audio Processing and Surround Sound*, on page 33.

To select a surround mode, press the Surround Modes button (front panel or remote). The Surround Modes menu will appear.

Surround Modes – Cable/Sat	
Auto Select – AVR Selects Best Mode	
Virtual Surround – For Two Speaker Systems	
Stereo:	2 CH Stereo
Movie:	Logic 7 Movie
Music:	Logic 7 Music
Video Game:	Logic 7 Game

Press the Up/Down buttons repeatedly until the desired surround-mode category appears: Auto Select, Virtual Surround, Stereo, Movie, Music or Video Game. Press the OK button to change the surround-mode category.

**Auto Select:** For digital programs, such as a movie recorded with a Dolby Digital or DTS soundtrack, the AVR will automatically use the soundtrack's native surround format. For two-channel analog and PCM programs, the AVR uses the Logic 7 Movie, Logic 7 Music or Logic 7 Game mode, depending on the source.

**Virtual Surround:** When only two main speakers are present in the system, you can use HARMAN Virtual Surround to create an enhanced soundfield that virtualizes the missing speakers. Select between Wide and Reference modes.

**Stereo:** When you want two-channel playback, select the number of speakers you want to use for playback:

- "2 CH Stereo" uses two speakers.
- "5 CH Stereo" plays the left-channel signal through the front left and surround left speakers, the right-channel signal through the front right and surround right speakers, and a summed mono signal through the center speaker.
- "7 CH Stereo" follows the same scheme as 5 CH Stereo but adds the surround back left and surround back right speakers. This mode is available only when the surround back speakers are present and have not been reassigned to multizone or front height operation. See *Audio Processing and Surround Sound*, on page 33, for more information.

**Movie:** Select from the following when you want a surround mode for movie playback: Logic 7 Movie, DTS Neo:6 Cinema or Dolby Pro Logic II (IIX or IIZ when seven main speakers are present).

**Music:** Select from the following when you want a surround mode for music playback: Logic 7 Music, DTS Neo:6 Music or Dolby Pro Logic II (IIX or IIZ when seven main speakers are present). The Dolby Pro Logic II/IIX/IIZ Music mode allows access to a submenu with some additional settings. See *Audio Processing and Surround Sound*, on page 33, for more information.

**Video Game:** Select from the following when you want a surround mode for game playback: Logic 7 Game or Dolby Pro Logic II (IIX/IIZ when seven main speakers are present) Game.

After you have made your selection, press the Back/Exit button.

See *Audio Processing and Surround Sound*, on page 33, for more information on surround modes.

### Audio Effects

The Audio Effects buttons on the front panel and remote provide settings that let you adjust the Dolby Volume setting, tone controls, LFE trim or EZ Set, Equalization On/Off setting. We recommend that you leave these settings at their default values until you are more familiar with your system. See *Audio Effects Button*, on page 34, for complete information.

### Video Modes

The Video Modes buttons on the front panel and remote provide settings that let you use the AVR's video processor to fine-tune the picture, if necessary, after making all adjustments on the video display. We recommend that you leave the settings at their defaults until you are completely familiar with the video performance of your system. See *Video Processing*, on page 34, for complete information.

## Advanced Functions

Much of the adjusting and configuration your AVR requires is handled automatically, with little intervention required on your part. You can also customize your AVR to suit your system and your tastes. In this section we will describe some of the more advanced adjustments available to you.

### Audio Processing and Surround Sound

Audio signals can be encoded in a variety of formats that can affect not only the quality of the sound but the number of speaker channels and the surround mode. You may also manually select a different surround mode, when available.

#### Analog Audio Signals

Analog audio signals usually consist of two channels – left and right. Your AVR is able to process two-channel audio signals to produce multichannel surround sound, even when no surround sound has been encoded in the recording. Among the available modes are the Dolby Pro Logic II/IIx/IIz, HARMAN Virtual Speaker, DTS Neo:6, Logic 7, 5 CH and 7 CH Stereo modes. To select one of these modes, press the Surround Modes button.

#### Digital Audio Signals

Digital audio signals offer greater flexibility and capacity than analog signals, and allow the encoding of discrete channel information directly into the signal. The result is improved sound quality and startling directionality, since each channel's information is transmitted discretely. High-resolution recordings sound extraordinarily distortion-free, especially in the high frequencies.

#### Surround Modes

Surround-mode selection depends upon the format of the incoming audio signal as well as your personal taste. Although there is never a time when all of the AVR's surround modes are available, there is usually a wide variety of modes available for a given input. Table A12 in the Appendix, on page 50, offers a brief description of each mode and indicates the types of incoming signals or digital bitstreams the mode may be used with. Additional information about the Dolby and DTS modes is available on the companies' Web sites: [www.dolby.com](http://www.dolby.com) and [www.dtsonline.com](http://www.dtsonline.com).

When in doubt, check the jacket of your disc for more information on which surround modes are available. Usually, nonessential sections of the disc, such as trailers, extra materials or the disc menu, are available only in Dolby Digital 2.0 (two-channel) or PCM two-channel mode. If the main title is playing and the display shows one of these surround modes, look for an audio or language setup section in the disc's menu. Also, make sure your disc player's audio output is set to the original bitstream rather than two-channel PCM. Stop play and check the player's output setting.

Multichannel digital recordings are produced in five-channel, six-channel or seven-channel formats, with or without a “.1” channel. The channels included in a typical 5.1-channel recording are front left, front right, center, surround left, surround right and LFE (low-frequency effects). The LFE channel is denoted as “.1” to represent the fact that it is limited to the low frequencies. 6.1-channel recordings add a single surround back channel, and 7.1-channel recordings add surround back left and surround back right channels to the 5.1-channel configuration. New formats are available in 7.1-channel configurations. Your AVR is able to play the new audio formats, delivering a more exciting home theater experience.

**NOTE:** To use the 6.1- and 7.1-channel surround modes, the surround back channels must be enabled. See *Manual Speaker Setup*, on page 36 for more information.

Digital formats include Dolby Digital 2.0 (two channels only), Dolby Digital 5.1, Dolby Digital EX (6.1), Dolby Digital Plus (7.1), Dolby TrueHD (7.1), DTS-HD High-Resolution Audio (7.1), DTS-HD Master Audio (7.1), DTS 5.1, DTS-ES (6.1 Matrix and Discrete), DTS 96/24 (5.1), two-channel PCM modes in 32kHz, 44.1kHz, 48kHz or 96kHz, and 5.1 or 7.1 multichannel PCM.

When the AVR receives a digital signal, it detects the encoding method and the number of channels, which is displayed briefly as three numbers, separated by slashes (e.g., “3/2/.1”).

The first number indicates the number of front channels in the signal: “1” represents a monophonic recording (usually an older program that has been digitally remastered or, more rarely, a modern program for which the director has chosen mono as a special effect). “2” indicates the presence of the left and right channels, but no center channel. “3” indicates that all three front channels (left, right and center) are present.

The second number indicates whether any surround channels are present: “0” indicates that no surround information is present. “1” indicates that a matrixed surround signal is present. “2” indicates discrete left and right surround channels. “3” is used with DTS-ES bitstreams to represent the presence of the discrete surround back channel, in addition to the side surround left and right channels. “4” is used with 7.1-channel digital formats to indicate the presence of two discrete side surround channels and two discrete back surround channels.

The third number is used for the LFE channel: “0” indicates no LFE channel. “.1” indicates that an LFE channel is present.

The 6.1-channel signals – Dolby Digital EX and DTS-ES Matrix and Discrete – each include a flag that signals the receiver to decode the surround back channel, indicated as 3/2/.1 EX-ON for Dolby Digital EX materials, and 3/3/.1 ES-ON for DTS-ES materials.

Dolby Digital 2.0 signals may include a Dolby Surround flag indicating DS-ON or DS-OFF, depending on whether the two-channel bitstream contains only stereo information or a downmix of a multichannel program that can be decoded by the AVR's Dolby Pro Logic decoder. By default, these signals are played in Dolby Pro Logic IIx Movie mode.

When a PCM signal is received, the PCM message and the sampling rate (32kHz, 44.1kHz, 48kHz or 96kHz) will appear.

When only two channels – left and right – are present, the analog surround modes may be used to decode the signal into multiple channels. If you would prefer a different surround format than the native signal's digital encoding, press the Surround Modes button to display the Surround Modes menu (see *Selecting a Surround Mode*, on page 32).

The Auto Select option sets the surround mode to the native signal's digital encoding, e.g., Dolby Digital, DTS, Dolby TrueHD or DTS-HD Master Audio. For two-channel materials, the AVR defaults to the Logic 7 Movie mode. If you prefer a different surround mode, select the surround-mode category: Virtual Surround, Stereo, Movie, Music or Video Game. Press the OK button to change the mode.

Each surround-mode category is set to a default surround mode:

- Virtual Surround: HARMAN virtual speaker.
- Stereo: 7-CH Stereo or 5-CH Stereo (depending on how many main speakers are present in the system).
- Movie: Logic 7 Movie.
- Music: Logic 7 Music.
- Video Game: Logic 7 Game.

You may select a different mode for each category. Below is a complete list of available surround modes. (The actual surround modes available will depend on the number of speakers in your system.)

- Virtual Surround: HARMAN virtual speaker.
- Stereo: 2-CH Stereo, 5-CH Stereo or 7-CH Stereo.
- Movie: Logic 7 Movie, DTS Neo:6 Cinema, Dolby Pro Logic II Movie, Dolby Pro Logic IIx Movie, Dolby Pro Logic IIz.
- Music: Logic 7 Music, DTS Neo:6 Music, Dolby Pro Logic II Music, Dolby Pro Logic IIx Music, Dolby Pro Logic IIz.
- Video Game: Logic 7 Game, Dolby Pro Logic II Game, Dolby Pro Logic IIx Game, Dolby Pro Logic IIz.

Once you have programmed the surround mode for each type of audio, select the line from the Surround Modes menu to override the AVR's automatic surround-mode selection. The AVR will use the same surround mode the next time the source is selected.

**NOTE:** Dolby Pro Logic IIx is available only if you have set up the AVR's Assigned Amp to Surround Back; Dolby Pro Logic IIz is available only if you have set up the AVR's Assigned Amp to Front Height. See *Manual Speaker Setup*, on page 36, for more information.

Please refer to Table A12 in the Appendix for more information on which surround modes are available with different bitstreams.

### Audio Effects Button

To adjust other audio settings, such as the tone controls, press the Audio Effects button to display the Audio Effects menu. You can also access the menu by pressing the Info button and selecting Audio Effects.

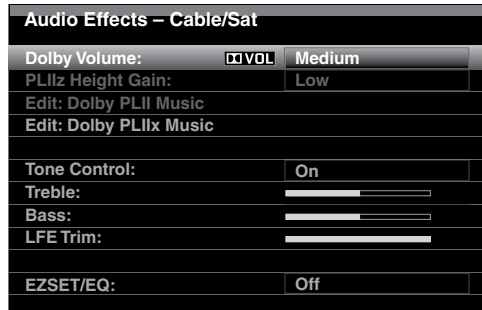

**NOTE:** Each source has its own independent Audio Effects settings.

**Dolby Volume:** See *Dolby Volume*, on page 28, for an explanation of Dolby Volume processing and its benefits. Refer to the table on that page for an explanation of each of the Dolby Volume settings.

**PLIIz Height Gain:** When you have set the Assigned Amp to Front Height (see *Manual Speaker Setup*, on page 36), the PLIIz Height Gain setting will become available. The front height channels can greatly improve the spatial experience of a surround-sound system. Some listeners may want the depth and dimension that height channels provide, but from a seemingly transparent experience. Other listeners may prefer to accentuate the front height channels by using a higher volume setting.

The PLIIz Height Gain control gives you the ability to change the volume of the front height channels to suit different programs. The control has three settings: Low (normal volume), Mid (moderate volume increase) and High (maximum volume increase). Note that you can also fine-tune the front height channel volume levels. See *Setting Channel Output Levels Manually*, on page 38, for details.

**Edit Dolby PLII/Dolby PLIIX Music:** Some additional settings are available for the Dolby Pro Logic II modes. When the Dolby Pro Logic II or IIX Music modes have been selected, choose the “Edit Dolby PLII/IIX Music” submenus to adjust the Center Width, Dimension and Panorama settings.

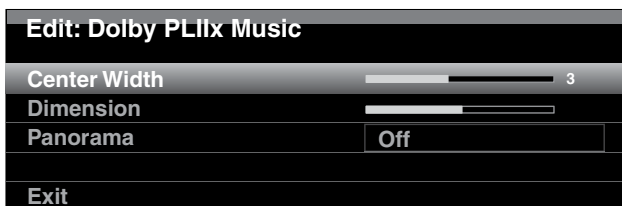

**Center Width:** This setting affects how vocals sound through the three front speakers. A lower number focuses the vocal information tightly on the center channel. Higher numbers (up to 7) broaden the vocal soundstage. Use the Left/Right buttons to adjust.

**Dimension:** This setting affects the depth of the surround presentation, allowing you to “move” the sound toward the front or rear of the room. The setting of “0” is a neutral default. Setting “F-3” moves the sound toward the front of the room, while setting “R-3” moves the sound toward the rear. Use the Left/Right buttons to adjust it.

**Panorama:** With the Panorama mode turned on, some of the sound from the front speakers is moved to the surround speakers, creating an enveloping “wraparound” effect. Each press of the OK button toggles the setting On or Off.

**Tone Control:** This setting determines whether the treble and bass controls are active. When it’s set to Off, the tone controls are out of the circuit, with no changes to the sound. When it’s set to On, the bass and treble controls are in the circuit.

**Treble/Bass:** These settings boost or cut the treble or bass frequencies by up to 10dB. Use the Left/Right buttons to change the setting. The default setting is 0dB, at the center of the bar.

**LFE Trim:** This setting attenuates the loudness of the LFE signal to the subwoofer. The setting defaults to the maximum of 0dB. Press the Left/Right buttons to reduce the level by up to 10dB; the setting will appear as a negative number. NOTE: This setting is effective only when a dedicated LFE-channel signal is present in the source material.

**EZ Set/EQ:** This setting activates or deactivates the equalization settings obtained when the EzSet/EQ II process was run. The settings are saved for reactivation at a later listening session.

When you have finished making adjustments, press the Audio Effects button or the Back/Exit button.

### Video Processing

The AVR’s video processor automatically provides the best picture based on the capabilities of your video display and the incoming source video. You may experiment with the Video Modes menu adjustments to try to improve the picture further.

Adjust your video display’s picture settings before adjusting the AVR’s Video Modes settings. Access the picture settings from the Video Modes menu. Press the Video Modes button, and the Video Modes screen will appear. You can also access the menu by pressing the Info button and selecting Video Modes.

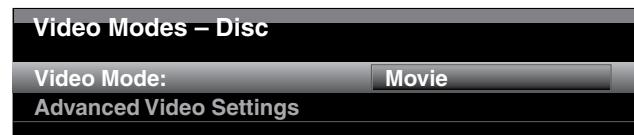

**NOTE:** Each source has its own independent Video Modes settings.

**Video Mode:** The default setting of Off passes the video signal through to the display with only basic video processing. (NOTE: Video scaling cannot be turned off, but selecting the HDMI Bypass mode in the Info menu for a source connected to one of the HDMI Input connectors passes the video signal directly from the HDMI input connector to the HDMI Monitor Out connector, bypassing all video processing.)

Select one of these processing options to optimize the picture for the current program by applying adjustments to the brightness, contrast, color and sharpness:

- Sports: For sporting events.
- Nature: For programs shot outdoors, in a natural setting.
- Movie: For movies and many television broadcasts.
- Custom: Lets you adjust the picture settings manually. The Brightness, Contrast, Color and Sharpness settings will appear as sliders with values ranging from 0 to 100. The default setting for each adjustment is 50. Use the Left/Right buttons to change each setting’s value. See *How to Adjust the Custom Picture Settings*, on page 35, for detailed information about making these adjustments.

### How to Adjust the Custom Picture Settings

Set the Video Mode to Custom to display the picture settings.

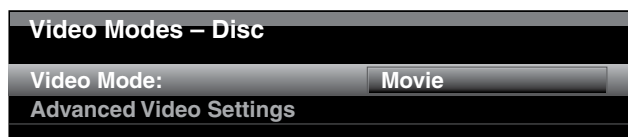

With a color-bar test pattern from a test disc or other source on the TV screen, you can make the following adjustments:

- The color intensity setting on your TV.
- Color adjustments using the color bars, which may be (left to right) black, white, yellow, cyan (turquoise), green, magenta, red, blue, black.
- The color transition, seen as sharp separation of the bars.
- The performance of the color circuits in your TV (with video signals); bar edges should show no vertical crawling dots.

Use the gray scale and the black/white fields in the test pattern to adjust the brightness and contrast.

#### Brightness Adjustment

1. Turn down the color control on your TV until the color bars appear in black and white.
2. Adjust the Contrast to the lowest level where you still can see all gray-scale bars separately and clearly.
3. Adjust the Brightness so that the bars in the gray scale are all visible. The bar farthest to the left has to be as black as possible rather than gray, but the next gradation must clearly be distinct from it. The bars in the gray scale should gradually and evenly change from black to white.

#### Contrast Adjustment

1. Adjust the contrast on your TV until you see a bright white bar in the lower right corner of the screen and a deep, dark, black bar to the left.
2. If the brightness of the white bar no longer increases when the Contrast is turned up or the borders of white letters bloom (overlight) into the black areas (drastically decreasing the sharpness of the letters), the contrast has been turned up too much. Reduce the Contrast until these effects disappear and the video still looks realistic.
3. If you are watching TV with ambient daylight, adjust the contrast so that a normal video picture looks the same as the surroundings in your room; that way the eye is relaxed when watching the TV picture. Reduce the setting when the surrounding light is dimmed to improve the sharpness of the picture.
4. The gray scale in the middle line should retain the same distinction between each bar as before the contrast adjustment. If not, repeat both Step 3 of the Brightness Adjustment and the Contrast Adjustment.

#### Color Adjustment

1. When the brightness and contrast are set optimally, adjust the Color control. Set the level so that the colors look strong but still natural, not overdone. If the color level is too high, depending on the TV, some of the bars will seem wider or the color intensity will not increase when the control is turned up. Test the color intensity with a video of pictures of faces, flowers, fruit and vegetables.
2. Refer to a large white bar in your test pattern to tweak the warmth of the picture using the Tint control on your TV.

### Sharpness Adjustment

Contrary to intuition, the picture will appear sharper and clearer with the sharpness backed off from the maximum setting. Reduce the Sharpness setting on your television, and the setting on the AVR, if necessary, to minimize the appearance of any white lines between the bars in the gray-scale portion of the test screen.

**Advanced Video Settings:** When the video mode is set to Custom, you can select this to display the Advanced Video Modes submenu.

Advanced Video Modes – Blu-ray	
Noise Reduction:	Off
MPEG Noise Reduction:	Off
Cross Color Suppressor:	Off
Film Mode Detect:	Off

**Noise Reduction:** Adjust this setting to Low, Medium or High to filter out signal noise.

**MPEG Noise Reduction:** This setting is designed to address two specific types of video distortion: mosquito noise and blocking artifacts. If you see haziness or shimmering around the edges of objects or the scrolling credits in a film, or if the image appears to “pixelate” into blocks, change the MPEG Noise Reduction setting from Off to Low, Medium or High.

**Cross Color Suppressor:** Turn this setting on to remove cross color artifacts, which can occur when high-frequency luminance (brightness) signals are misinterpreted as chrominance (color) signals, causing unwanted flickering, flashing colors or rainbow patterns. This setting is not available when you are using HDMI sources or when no video signal is present.

**Film Mode Detect:** This setting is accessible only when the Deinterlacing setting is turned on. It compensates for the different frame rates in which film and video are shot. Film is shot at a rate of 24 frames per second (progressive scan), while video is shot at slightly less than 60 frames per second (interlaced). The AVR is able to detect whether the program was originally shot on film and transferred to video (e.g., to create a DVD), and will compensate appropriately for any authoring errors in the conversion. Select a setting of 3:2 (for NTSC materials), 2:2 (for PAL materials), Off or Auto.

## Manual Speaker Setup

Your AVR is flexible and may be configured to work with most speakers and to compensate for the acoustic characteristics of your room.

The EzSet/EQ process automatically detects the capabilities of each connected speaker and optimizes the AVR's performance with your speakers. If you are unable to run EzSet/EQ calibration, or if you wish to set up your AVR for your speakers manually, use the Manual Speaker Setup on-screen menus.

Before beginning, place your loudspeakers as explained in the *Place Your Speakers* section, on page 13, and connect them to the AVR. Consult the owner's guide for the speakers or the manufacturer's Web site for their frequency-range specification. Although you may set the AVR's individual channel levels "by ear," an SPL (sound-pressure level) meter purchased at a local electronics store will provide greater accuracy.

Record your configuration settings in Tables A3 through A12 in the Appendix for easy re-entry after a system reset or after the AVR's Master Power switch has been turned off or the unit has been unplugged for more than four weeks.

**NOTE:** When using the AVR's Manual Speaker Setup menus, select a video output resolution of 720p or higher to view graphics that simplify configuration.

### Step One – Determine Your Speakers' Crossover Frequencies

Without using the EzSet/EQ process, the AVR can't detect how many speakers you've connected to it; nor can it determine their capabilities. Consult the technical specifications for all of your speakers and locate the frequency response, usually given as a range, e.g., 100Hz – 20kHz ( $\pm 3$ dB). Write down the lowest frequency that each of your speakers is capable of playing (100Hz in the above example) as the crossover in Table A3 in the Appendix. **NOTE:** This is not the same as the crossover frequency listed in the speaker's specifications.

For the subwoofer, write down the transducer size. The AVR's bass management determines which speakers will be used to play back the low-frequency (bass) portion of the source program. Sending the lowest notes to small satellite speakers will result in bad sound and may even damage the speakers. The highest notes may not be heard at all through the subwoofer.

With proper bass management, the AVR divides the source signal at a crossover point. All information above that crossover point is played through your system's speakers, and all information below the crossover point is played through the subwoofer. This way, each loudspeaker in your system will perform at its best, delivering a more powerful and enjoyable sound experience.

### Step Two – Measure the Speaker Distances

Ideally, all of your speakers would be placed in a circle, with the listening position at the center. However, you may have had to place some speakers a little farther away from the listening position than others. Sounds that are supposed to arrive simultaneously from different speakers may blur, due to different arrival times.

Your AVR provides a Distance adjustment that compensates for these real-world speaker placement differences.

Measure the distance from each speaker to the listening position, and write it down in Table A4 in the Appendix. Even if all of your speakers are the same distance from the listening position, enter your speaker distances as described in *Set the Speaker Distances*, on page 38.

### Step Three – Manual Speaker Setup Menu

Now you are ready to program the receiver. Sit in your usual listening position, and make the room as quiet as possible.

With the receiver and video display turned on, press the AVR button to display the menu system. Select the Speaker Setup menu, and then select Manual Setup.

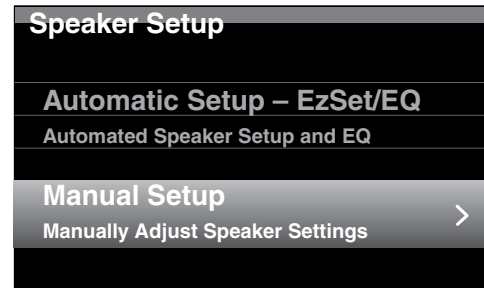

If you have already run the EzSet/EQ process as explained in *Configure the AVR for Your Speakers*, on page 25, the AVR saved the results. To fine-tune the EzSet/EQ results, or to configure the AVR from scratch, select Manual Setup. A screen similar to the one shown below will appear.

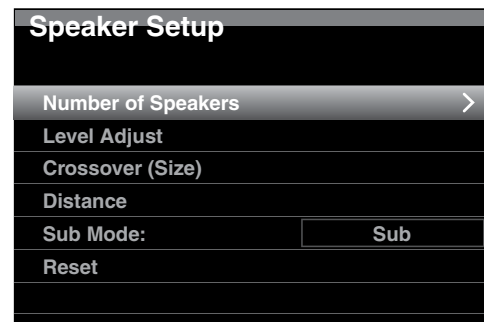

**NOTE:** All of the speaker setup submenus include the Back option. To save the current settings, select the Back option.

To reconfigure the speakers from scratch, select the Reset option.

For best results, adjust the submenus in this order: Number of Speakers, Crossover (Size), Sub Mode, Distance and Level Adjust.

#### Number of Speakers

This selection lets you program the correct setting for each speaker group. The settings in this menu affect the remainder of the speaker setup process and the availability of various surround modes at any time.

Select ON when the speakers are present in the system; select OFF for positions where no speakers are installed. The Front Left & Right setting is always ON and may not be disabled.

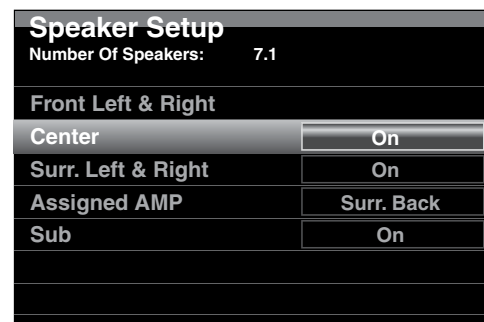

Any changes will be reflected in the total Number Of Speakers displayed at the top of the screen.

The Assigned AMP setting includes four options:

- **Surround Back:** Select the Surr. Back option if your main system is a 7.1-channel system and you are using surround back left and surround back right speakers.
- **Zone 2:** Select the Zone 2 option if your main system is a 5.1-channel system and you want to use the Assigned Amp speaker outputs to power speakers in Zone 2. See *Install a Multizone System*, on page 21, for more information.
- **Front Height:** Select the Front Height option if your main system is a 7.1-channel system and you are using Front Height speakers with Dolby Pro Logic IIz.
- **Off:** Select Off if you have not connected speakers to the Assigned Amp speaker outputs.

**NOTE:** When you set Assigned AMP to “Zone 2,” the speakers connected to the Assigned Amp outputs will not be configured during the EzSet/EQ process. Configure the speakers manually, as explained below.

When you have finished, select the Back option or use the Back/Exit button.

### Crossover (Size)

After you return to the Speaker Setup menu, navigate to the Crossover (Size) line and press the OK button to display the Adjust Crossover Frequencies menu.

Speaker Setup	
Adjust Crossover Frequencies	
Front Left & Right	80 Hz
Center	80 Hz
Surr. Left & Right	100 Hz
Surr. Back L & R	100 Hz
Sub Size	80 Hz
Reset Crossover	

The AVR will display only those speaker groups you set to On in the Number of Speakers menu.

Refer to Table A3 to see the crossover frequencies that you wrote down for your speakers.

For each speaker group, select one of these eight crossover frequencies: Large, 40Hz, 60Hz, 80Hz, 100Hz, 120Hz, 150Hz or 200Hz. If the speaker’s crossover frequency is below 40Hz, select the first option, “Large.” This setting doesn’t refer to the speaker’s physical size but to its frequency response, which is also called “full range.”

We recommend that you set the Subwoofer Crossover Frequency to the same frequency you used for the Front Left & Right speaker setting. If you set the Front Left & Right speakers to “Large”, we recommend that you experiment with different Subwoofer Crossover Frequency settings to find the one that produces the best blend between the subwoofer and Front Left & Right speakers with your system in your room.

Write down the settings in Table A6 in the Appendix.

When you have finished entering the settings, select Back or press the Back/Exit button.

### Sub Mode

Move the cursor to the Sub Mode line. This setting depends upon the Crossover setting you selected for the front left and right speakers.

- If you set the front speakers to a numeric crossover frequency, the subwoofer setting will always be SUB. All low-frequency information will always be sent to the subwoofer. If you don’t have a subwoofer, either upgrade to full-range front left and right speakers or add a subwoofer at the earliest opportunity.
- If you set the front speakers to LARGE, select one of the three following settings for the subwoofer:

**L/R+LFE:** This setting sends all low-frequency information to the subwoofer, including a) information that would normally be played through the front left and right speakers and b) the special low-frequency effects (LFE) channel information.

**OFF:** Select this setting when no subwoofer is in use. All low-frequency information will be sent to the front left and right speakers.

**LFE:** This setting plays low-frequency information contained in the left and right program channels through the front left and right speakers, and directs only the LFE-channel information to the subwoofer.

### Set the Speaker Distances

As described above in Step Two, when you measured the distances from each of your speakers to the listening position, your AVR provides an adjustment that compensates for the different distances so that the sound from each speaker will reach the listening position at the proper time. This process will improve the clarity and detail of the sound.

On the Speaker Setup menu, move the cursor to the Distance line and press the OK button to display the Adjust Speaker Distance menu.

Speaker Setup	
Adjust Speaker Distance	
Front Left	10 ft
Center	
Front Right	
Surround Right	
Surround Back Right	
Surround Back Left	
Surround Left	
Sub	

Enter the distance from each speaker to the listening position that you measured in Step Two and recorded in Table A4 in the Appendix (see page 46). Select a speaker, then use the Left/Right buttons to change the measurement. You can enter distances between 0 and 30 feet (9.1m). The default distance for all speakers is 10 feet (3m).

The default unit of measurement is feet. To change the unit to meters, return to the main AVR menu. Select the System Settings menu, then scroll down to the General Setup section and select the Unit of Measure line. Press the OK button to change the setting.

**NOTE:** If you set the Assigned AMP channels to Zone 2, you will not be able to adjust their delay settings.

## Step Four – Setting Channel Output Levels Manually

For a conventional stereo receiver, a simple balance control adjusts the stereo imaging by varying the relative loudness of the left and right channels. In a home theater system with up to seven main channels plus up to two subwoofers, achieving proper imaging becomes both more critical and more complex. The goal is to ensure that each channel is heard at the listening position with equal loudness (when signals of equal loudness are played through them).

Your AVR's EzSet/EQ calibration can handle this critical task for you simply and automatically. However, the AVR's Adjust Speaker Levels menu allows you to calibrate the levels manually, either using the system's built-in test tone or while playing source material.

Press the AVR button to display the menu system, and then navigate to the Speaker Setup line. Press the OK button to display the Speaker Setup menu. Select Manual Setup, press the OK button, and then navigate to the Level Adjust line. Press the OK button to display the Adjust Speaker Levels menu.

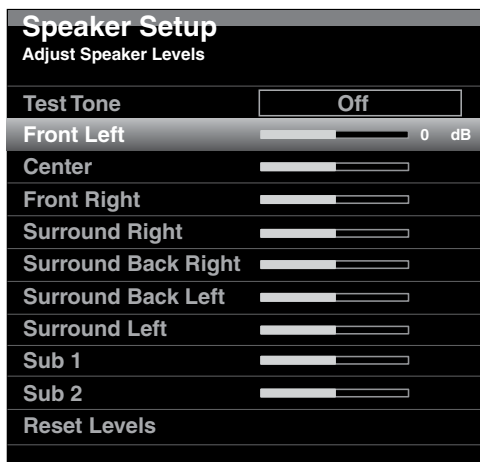

All of the system's speakers will appear with their current level settings. You can adjust each speaker's level between -10dB and +10dB in 1dB increments.

While making adjustments, you can measure the channel levels in one of these ways:

- Preferably, use a handheld SPL meter set to the C-weighting, slow scale. Adjust each speaker so that the meter reads 75dB when the AVR's built-in test noise is playing.
- By ear. Adjust the levels so that the test tone sounds equally loud to you when it plays through each speaker.

To set your levels using the AVR's internal test tone, select the menu's Test Tone line and use the OK button to select between Auto and Manual:

**Auto:** The test tone will automatically circulate to all speakers, as indicated by the highlight bar. Use the Left/Right buttons to adjust the level for any speaker when the test tone is paused there. Use the Up/Down buttons to move the cursor to another line, and the test tone will follow the cursor. To stop the test tone, use the Up/Down buttons to move the cursor out of the screen's speaker listings area.

**Manual:** The test tone will stay on the current speaker until you use the Up/Down buttons to move it to another speaker. Use the Left/Right buttons to adjust the level for the speaker through which the test tone is playing.

If you are using an external source to set your output levels, set Test Tone to Off, use the Up/Down buttons to navigate to each speaker, and use the Left/Right buttons to adjust the speaker's level while the source plays. **NOTE:** If you are using a handheld SPL meter with external source material, such as a test disc or an audio selection, play it and adjust the AVR's master volume control until the meter measures 75dB. Then adjust the individual speaker levels.

**Reset Levels:** To reset all levels to their factory defaults of 0dB, scroll down to this line at the bottom of the menu and press the OK button.

When you have finished adjusting the speaker levels, record the settings in Table A3 in the Appendix. Then select the Back option or press the Back/Exit Button.

## Notes on Setting Speaker Volumes in Home Theater Systems:

While setting your system's individual speaker volume levels is ultimately up to your personal taste, here are some ideas you may find helpful:

- For films and video-music programs, your overall goal should be to create an enveloping, realistic sound field that draws you into the film or music program without drawing your attention away from the action on the screen.
- For multichannel music recordings, some music producers will create a sound field that places the musicians all around you; others will create a sound field that places the musicians in front of you, with more subtle ambience in the surround speakers (as you would experience in a concert hall).
- In most 5.1-channel and 7.1-channel film soundtracks, the surround speakers are not intended to be as loud or as active as the front speakers. Adjusting the surround speakers so they are always as loud as the front speakers could make dialogue difficult to understand and will make some sound effects sound unrealistically loud.

## Notes on Setting Subwoofer Volume:

- Sometimes the ideal subwoofer volume setting for music is too loud for films, while the ideal setting for films is too quiet for music. When setting the subwoofer volume, listen to both music and films with strong bass content and find a "middle ground" volume level that works for both.
- If your subwoofer always seems too loud or too quiet, you may want to place it in a different location. Placing the subwoofer in a corner will always tend to increase its bass output, while placing it away from any walls or corners will always tend to lessen its bass output.



## Listening in Zone 2

With the multizone system in use, you may enjoy an exciting 5.1-channel home theater presentation in the main listening area, while others listen to the same program or an entirely different source in another room. See *Install a Multizone System*, on page 21, for installation information.

You control the AVR's multizone system from the on-screen Zone 2 menu. Press the AVR button, and use the Up/Down buttons to navigate to the Zone 2 line. Press the OK button to display the Zone 2 menu.

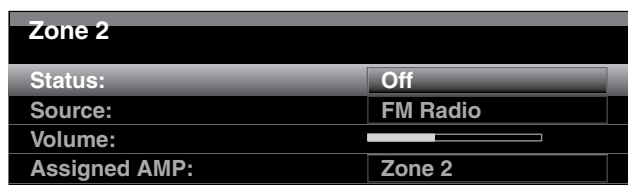

**Status:** This line lets you turn Zone 2 on or off.

**Source:** This line lets you select the source input for Zone 2. You may select a different source from the one currently operating in the main listening area. However, if the same source has been selected for both the main listening area and Zone 2, listeners in both areas will hear the same content.

Only analog audio sources are available to the multizone system. To hear digital devices such as a CD player in Zone 2, follow these steps:

1. In addition to making a digital audio connection, connect the source device's analog audio outputs to the AVR. Make a note in Table A5 on page 47 to record which set of analog inputs you used.
2. In the Info menu, scroll down to the Zone 2 Audio setting and select the analog audio input. (Leave the Audio Input From Source set to the digital input.)

### Notes about listening in Zone 2:

- Although you can listen to iPod as a source in Zone 2, you cannot begin iPod playback from within Zone 2. You must initially select iPod as a source in Zone 1 and begin playback of a track or playlist from there. Then you can select iPod as the Zone 2 source and control playback from within Zone 2 even if you switch Zone 1 to a different source.
- Only one (1) internal source (iPod, USB, FM/AM radio, vTuner, Network) can be active at a time across both zones. For example, if you are listening to iPod as the source in Zone 1 and switch the source in Zone 2 to FM radio, it will switch the source in Zone 1 to FM (and vice versa). To listen to different sources in Zone 1 and Zone 2 at the same time, at least one source must be one of the AVR's configurable external sources (Cable/Sat, Disc, DVR, TV, Game, Media Server, Aux, Buttons A/B/C/D) that is connected to one of the AVR's analog audio inputs.

**Volume:** Highlight this line, and use the Left/Right buttons to control the volume in Zone 2.

**Assigned AMP:** This line lets you assign the Assigned AMP channels to "Zone 2" for multizone operation (see *Number of Speakers*, on page 37). When this line is set to Zone 2, you may configure the main listening room for only up to 5.1 channels.

To operate the multizone system using the main remote, slide the Zone Select Switch at the bottom of the remote to the "2" position.

**AVR 3700/AVR 370 only:** To select a zone using the Zone 2 remote, press the Zone Selector, and the Zone Indicator light will turn green when the remote is set to operate Zone 1 or red to operate Zone 2.

## System Settings

The AVR's System Settings menu lets you customize in what way many of the AVR's features operate. Press the AVR button and navigate to the System line. Press the OK button to display the System Settings menu.

System Settings	
Front Panel Settings	
Panel Brightness:	100%
HDMI Settings	
HDMI Audio to TV:	On
HDMI Control:	HDMI out 1
Audio Return Channel:	Auto
CEC Power Control:	Off
TV Control:	Off
General AVR Settings	
Network Settings	
Volume Units:	dB
Volume Default:	Off
Volume Default Level	<input type="range"/>
Unit of Measure:	Feet (ft)
Language:	English

System Settings	
Volume Default:	Off
Volume Default Level	<input type="range"/>
Unit of Measure:	Feet (ft)
Language:	English
Dolby Vol. Calibration:	<input type="range"/>
RS232 Control:	Off
Menu Appearance	
Menu Transparency:	Medium
Volume/Status Messages:	3 seconds
Menus:	30 seconds
Setup and Slide-In Menus:	5 minutes
Screen Saver:	10 minutes
System Info	
Software Version:	13-10-2012 01
Upgrade Software	>

**Front-Panel Dimmer:** This control sets the brightness of the AVR's front-panel message display. Select from 100%, 50%, 25% or Off. The light inside the Volume Control will glow out when the display is partly or fully dimmed, but the Power Indicator will always remain lit to remind you that the AVR is powered on.

### HDMI Settings

**HDMI Audio to TV:** This setting determines whether HDMI audio signals are passed through the HDMI Monitor Out connector to the video display. In normal operation, leave this setting at Off, as audio will be played through the AVR. To use the TV by itself, without the home theater system, turn this setting to On. In this case you will need to mute the TV's speakers (or switch the setting to Off) when using the AVR for audio.

**HDMI Control:** This setting allows the communication of control information among the HDMI devices in your system. Turn this setting to On to allow control communication between the HDMI devices; turn the setting to Off to forbid control communication. (For AVR 3700/AVR 370 select HDMI Out 1, HDMI Out 2 or Off.)

**Audio Return Channel:** Selecting "Auto" will send audio from the TV to the AVR via the HDMI Audio Return Channel (ARC) connection (which is in the HDMI cable connecting the AVR to the TV). The TV source's "Audio Input from Source" will be automatically reassigned to the HDMI ARC connector. This way, whenever you're watching a source that is connected directly to your TV (such as an Internet connection), you can listen to the sound through the AVR.

**CEC Power Control:** This setting links the power on/off functions of the AVR to those of a TV connected to its HDMI Monitor Out connector. When Power Control is set to On, turning the TV's power off will automatically put the AVR into the Standby mode; turning the TV's power on will automatically turn the AVR on. **NOTE:** The connected TV must support the HDMI System Standby CEC (Consumer Electronics Control).

**TV Control:** This setting extends some audio-control functions between the AVR and a TV connected to its HDMI Monitor Out connector. When TV Control is set to On, if the TV is set to use external speakers, the TV's internal speakers will mute, and you can use the TV's remote to control the AVR's volume up/down and mute functions. If the TV is set to use its internal speakers, the AVR's output will automatically mute. **NOTE:** The connected TV must support the HDMI Remote Control/System Audio Control CEC (Consumer Electronics Control).

### General AVR Settings

**Network Settings:** Select this to set up your AVR for connection to your wired home network. Note: The AVR 3700 and AVR 370 will first present a Wired/Wireless/Network Upgrade screen. For information about the Wired Network connection screen, see *Set Up the Network*, on page 27.

Network Settings	
Mac	0x:00:0x:00:0x:0x
Network Settings:	Automatic
IP Address:	000 . 000 . 000 . 000
Subnet Mask:	000 . 000 . 000 . 000
Gateway:	000 . 000 . 000 . 000
Primary DNS:	000 . 000 . 000 . 000
Secondary DNS:	000 . 000 . 000 . 000
Proxy	Off
IP Address:	000.000.000.000
Proxy Port:	00000
Network Status:	Connected
Apply & Save	

- **Mac:** This line is informational only and identifies the AVR to other devices on your home network and the Internet for [www.radioharmankardon.com](http://www.radioharmankardon.com).
- **Network Settings:** Since most networks use automatic IP address settings, in most cases you can set Network Settings to Automatic. If you are required to use a static IP address and network settings, you must obtain these settings from your ISP or network administrator. Use the OK button to set this line to "Manual." The following settings will become active: IP Address, Subnet Mask, Gateway, Primary DNS, Secondary DNS. If your network is a proxy network, enter those settings for Proxy, the second IP Address and Proxy Port.

Use the Number buttons to make the entries for all of these settings. When you have finished, select Apply & Save, and press the OK button. The AVR will enter the Standby mode. When you turn the AVR back on, it will attempt to connect to the network using the settings you entered. If the AVR cannot connect to the network using the manual settings, contact your ISP or network administrator for assistance.

- **Network Status:** This line indicates the AVR's current network-connection status (Connected/Not Connected).
- **Apply & Save:** Any time you make a change in any of the Network settings, the Apply & Save line will become available. Select this line and press the OK button. The AVR will go into the Standby mode. After you turn the AVR back on, the new network settings will be in effect. **IMPORTANT: You must select Apply & Save for your network settings to take effect.**

**NOTE: If you have trouble connecting to the network at any time, cycle the AVR into the Standby mode, and then turn it back on.**

**Volume Units:** This setting lets you select whether the AVR displays the volume level in the conventional decibel scale or on a numeric scale from 0 to 100. When the decibel scale is used, 0dB is the maximum recommended volume, with lower volumes displayed as negative values. (-90dB – +10dB). The decibel scale is the default setting.

**Volume Default and Volume Default Level:** These two settings are used together to program the volume level when you turn on the AVR. Set Volume Default to On, and then set the Volume Default Level to the desired turn-on volume. When Volume Default is set to Off, the AVR will turn on at the last-used volume setting from the previous listening session.

**Unit of Measure:** Adjusts the speaker-distance settings for Manual Speaker Setup. Select between meters and feet.

**Language:** Select the preferred language for the AVR's on-screen menus and displays: English, French, Spanish, German, Italian or Russian.

**Dolby Volume Calibration:** This setting determines the Dolby Volume calibration, as described in *Dolby Volume Calibration*, on page 28. Refer to that section for details about setting the calibration.

**RS232 Control:** If you have connected the AVR to an external control system via its RS-232 port, set this line to On to enable the AVR to be controlled by the external control system. Refer to the control system's documentation for details.

### Menu Appearance

**Menu Transparency:** This selection lets you determine whether video programs will be visible when the menu system is in use. Select Normal for a fully transparent background, Medium for partial transparency or Opaque to completely block video programs while menus are on screen.

**Volume/Status Messages:** When the AVR is turned on, the volume is adjusted, the source is changed or a change in the input signal is detected, a status message will be displayed on the TV screen. Select how long the message remains visible, from 2 to 10 seconds, with a default of 3 seconds. Select "Off" if you do not wish to see the status messages on the TV screen (they will still appear on the AVR's front-panel message display).

**Menus:** This setting governs how long the Surround Modes, Video Modes and Audio Effects menus remain visible after the last adjustment: 5 seconds, 10 seconds, 30 seconds, 1 minute or 5 minutes. Select "No Time-Out" to view the menus indefinitely, but this setting is not recommended, due to the danger of "burn-in" on some video displays.

**Setup and Slide-In Menus:** This setting determines how long the setup menus (Main Menu, Speaker Setup Menu, Zone 2 Menu, all slide-in menus) remain visible after the last adjustment. Select a time-out period of 5, 10 or 15 (the default) minutes, or no time-out, which leaves the menus on screen until manually cleared. A time-out period avoids the possibility of burn-in damage to plasma or CRT displays.

**Screen Saver:** Program a time-out period for no activity (with no menus displayed) before the AVR's built-in screen saver begins. Select a period of 5 minutes, 10 minutes, 20 minutes, 30 minutes or 1 hour, or turn off the screen saver. A time-out period avoids the possibility of burn-in damage to plasma or CRT displays.

### System Info

**Software Version:** This line is informational only. From time to time, Harman Kardon engineers may release software upgrades that improve your AVR's performance or add features. If you are experiencing difficulties with the AVR, a customer-service representative may ask for the software version of your AVR to determine whether a later upgrade is available.

**Upgrade Software:** If a software upgrade is released for your AVR, installation instructions will be available in the Product Support section of the Web site or from Harman Kardon customer service. At that time, you may access this submenu to install the upgrade software.

**IMPORTANT:** During a system upgrade, do not power off the AVR or use any of its controls. Doing so could permanently damage the AVR.

### Settings Lock

Settings Lock prevents the Setup Source, Speaker Setup and System settings menus from being inadvertently changed. With Settings Lock set to On, the screen shown below will appear whenever someone attempts to access a setting in one of those menus.

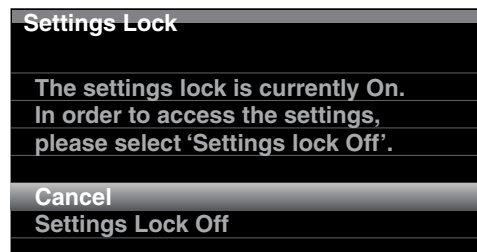

Select "Settings Lock Off" to access the settings or "Cancel" if the setting was accessed inadvertently. NOTE: If you select "Settings Lock Off," you will need to turn the Settings Lock back on via the Settings Lock menu.

## Advanced Remote Control Programming

### Remote Channel-Control Punch-Through

The punch-through feature allows you to operate one component while setting certain groups of controls to operate another component. For example, while using the AVR controls for surround modes and other audio functions, you may also use the remote to operate the transport controls of your Blu-ray Disc player. Or while using the remote to control video functions on your TV, you may also use the remote to change channels on your cable box.

To program punch-through control while operating any device:

1. For three seconds press and hold the Source Selector button for the main device the remote will be operating. The Source Selector will light up, go dark and then light up again, indicating the remote is in Program mode and that you may release the button.
2. Select the type of punch-through programming.
  - a) For channel-control punch-through, press the Channel Up button.
  - b) To program transport-control punch-through, press the Play transport-control button.
3. Press the Source Selector button for the device whose channel or transport controls you will use while operating the device selected in the first step. The Source Selector button will flash to confirm.

For example, to watch the TV while changing channels using the cable box, press and hold the TV button until it lights. Then press the Channel Up button, followed by the Cable/SAT button.

To undo punch-through programming, follow the same steps as above, but press the same Source Selector button in Steps 1 and 3.

**NOTE:** The Volume and Mute controls are always dedicated to the AVR.

### Programming Macro (Activity) Commands

In addition to their normal functions, you can also use the 0 – 9 Number buttons and AVR Power On button to store Macro (Activity) commands – up to 11 of them. Each Macro can send out up to 19 commands at one time from a single button push. Any AVR remote control button's function from any mode (except the Back/Exit button, the Light button, and the Activity button) can be programmed into a Macro.

**NOTE:** Use caution when programming complicated Macros. It isn't possible to program a pause or delay before sending additional commands after a "Power On" command, and the component may not be ready to respond to commands immediately after powering on.

To program a Macro:

1. To enter the Programming mode, simultaneously press and hold the Activity button and the Number button or AVR Power On button to which you want to assign the Macro.
2. Press in up to 19 commands that you want stored in that Macro button. During each successive button selection, the Source Selector button LED will blink once. Press the Source Selector button for each device (or Setup button for the AVR itself) before you enter individual commands. This step counts as one of the 19 commands allowed for each Macro.
  - You can select functions from another mode by first pressing the corresponding Source Selector button and then the buttons where those functions are located within that mode. Pressing a Source Selector button also counts as one command.
  - For power on, press the AVR or Device Power On button.
  - For power off, press the AVR or Device Power Off button.
3. Press the Activity button to end the programming process. The last Source Selector button (or the Setup button) will flash three times.

It isn't possible to "edit" a command within a Macro. To erase the Macro:

1. Press and hold the Activity Button and the button into which you programmed the Macro until the Source Selector or Setup button lights up.
2. Press the Activity button to erase the Macro.

To execute a Macro:

Press the Activity button, then press the button into which you programmed the Macro.

**IMPORTANT:** Keep the remote aimed at the components until all of the Macro commands have been executed. The remote can take up to 10 seconds to send out 19 Macro commands.

### Recording

Two-channel analog audio signals, as well as composite video signals, are normally available at the appropriate recording outputs. To make a recording, connect your audio or video recorder to the appropriate AVR output connectors as described in the *Making Connections* section, insert blank media in the recorder and make sure the recorder is turned on and recording while the source is playing. Refer to the recording device's instructions for complete information about making recordings.

#### NOTES:

1. The AVR only records analog audio signals. It does not convert digital audio signals to analog.
2. HDMI and component video sources are not available for recording.
3. Please make certain that you are aware of any copyright restrictions on any material you record. Unauthorized duplication of copyrighted materials is prohibited by law.

### Sleep Timer

The sleep timer sets the AVR to play for up to 90 minutes and then turn off automatically.

Press the Sleep button on the remote, and the time until turn-off will be displayed. Each additional press of the Sleep button increases the play time by 10 minutes, with a maximum of 90 minutes. The SLEEP OFF setting disables the sleep timer.

When the sleep timer has been set, the front-panel display will automatically dim to half brightness.

If you press the Sleep button after the timer has been set, the remaining play time will be displayed. Press the Sleep button again to change the play time.

### Resetting the Remote

To reset the remote to its factory default condition, simultaneously press and hold the TV Source Selector button and the "0" Number button. When the TV Source button relights, enter the code "333." When the TV button goes out, and all of the Source Selector buttons flash, the remote control will be reset.

### Processor Reset

If the AVR behaves erratically after a power surge, first turn off the rear-panel Main Power switch and unplug the AC power cord for at least 3 minutes. Plug the cord back in and turn the receiver on. If this procedure doesn't help, reset the AVR's processor as described below.

**NOTE:** A processor reset erases all user configurations, including video resolution, speaker and level settings, and tuner presets. After a reset, reenter all of these settings from your notes in the Appendix worksheets.

#### To reset the AVR's processor:

1. Press the front-panel Standby/On switch to place the unit in the Standby mode (the Power Indicator will turn amber).
2. Press and hold the front-panel Surround Modes button for at least 5 seconds until the RESET message appears on the front-panel Message Display.

**NOTE:** After performing a processor reset, wait at least 1 minute before pressing any Source Selector buttons.

If the receiver does not function correctly after a processor reset, contact an authorized Harman Kardon service center for assistance. Authorized service centers may be located by visiting our Web site at [www.harmankardon.com](http://www.harmankardon.com).

Symptom	Cause	Solution
Unit does not function when Main Power switch is turned on	<ul style="list-style-type: none"> <li>No AC power</li> </ul>	<ul style="list-style-type: none"> <li>Ensure that the power cord is plugged into a live AC power outlet</li> <li>Check if the AC outlet is switch-controlled</li> </ul>
Front-panel Message display lights, but there's no sound or picture	<ul style="list-style-type: none"> <li>Intermittent input connection</li> <li>Mute is on</li> <li>Volume control is turned down</li> </ul>	<ul style="list-style-type: none"> <li>Secure all input and speaker connections</li> <li>Press Mute button</li> <li>Turn up Volume control</li> </ul>
No sound from any speaker; PROTECT message appears on Message display	<ul style="list-style-type: none"> <li>Amplifier is in protection mode due to possible short circuit</li> <li>Amplifier is in protection mode due to internal problems</li> </ul>	<ul style="list-style-type: none"> <li>Check all speaker wires at speaker and AVR connections for crossed wires</li> <li>Contact your local Harman Kardon service center</li> </ul>
No sound from center or surround speakers	<ul style="list-style-type: none"> <li>Incorrect surround mode</li> <li>Program material is monophonic</li> <li>Incorrect speaker configuration</li> <li>Program material is stereo</li> </ul>	<ul style="list-style-type: none"> <li>Select a surround mode other than stereo</li> <li>Mono programs contain no surround information</li> <li>Check the speaker configuration in the setup menu</li> <li>The surround decoder may not create center- or surround-channel information from nonencoded programs</li> </ul>
Unit does not respond to remote control commands	<ul style="list-style-type: none"> <li>Weak batteries in remote</li> <li>Remote sensor is obscured</li> </ul>	<ul style="list-style-type: none"> <li>Change batteries in remote</li> <li>Ensure that the AVR's front-panel remote sensor is in the line of sight of the remote</li> </ul>
Intermittent buzzing in tuner	<ul style="list-style-type: none"> <li>Local interference</li> </ul>	<ul style="list-style-type: none"> <li>Move the AVR or antenna away from computers, fluorescent lights, motors or other electrical appliances</li> </ul>
<b>(AVR 3700/AVR 370 only):</b> Surround-back speaker settings cannot be accessed, and the test tone does not play through the surround back speakers	<ul style="list-style-type: none"> <li>Multi-zone operation has been selected/Assigned AMP channels have been assigned to Zone 2</li> </ul>	<ul style="list-style-type: none"> <li>Use the Speaker Setup menu to reassign the Assigned AMP to the surround back left and right channels</li> </ul>
Unable to activate remote control Programming mode	<ul style="list-style-type: none"> <li>Source Selector button is not held for at least 3 seconds</li> </ul>	<ul style="list-style-type: none"> <li>Be sure to hold the Source Selector button for at least 3 seconds</li> </ul>
Remote buttons light, but AVR does not respond	<ul style="list-style-type: none"> <li>Remote is in Zone 2 mode</li> </ul>	<ul style="list-style-type: none"> <li>Slide Zone Selector switch to the Zone 1 position.</li> </ul>
Unable to establish network connection	<ul style="list-style-type: none"> <li>AVR network programming requires rebooting</li> </ul>	<ul style="list-style-type: none"> <li>Cycle the AVR into the Standby mode, and then turn it on again</li> </ul>

Additional information on troubleshooting possible problems with your AVR and installation-related issues may be found in the list of "Frequently Asked Questions," which is located in the Product Support section of our Web site: [www.harmankardon.com](http://www.harmankardon.com)

## Specifications

### Audio Section

Stereo power:	AVR 3700/AVR 370: 125W per channel, two channels driven @ 6/8 ohms, 20Hz – 20kHz, <0.07% THD AVR 2700/AVR 270: 105W per channel, two channels driven @ 6/8 ohms, 20Hz – 20kHz, <0.07% THD
Multichannel power:	AVR 3700/AVR 370: 125W per channel, two channels driven @ 6/8 ohms, 20Hz – 20kHz, <0.07% THD AVR 2700/AVR 270: 105W per channel, two channels driven @ 6/8 ohms, 20Hz – 20kHz, <0.07% THD
Input sensitivity/impedance:	250mV/27k ohms
Signal-to-noise ratio (IHF-A):	100dB
Surround system adjacent channel separation:	Dolby Pro Logic/DPLII: 40dB Dolby Digital: 55dB DTS: 55dB
Frequency response (@ 1W):	10Hz – 130kHz (+0dB/–3dB)
High instantaneous current capability (HCC):	±42 amps (AVR 3700/AVR 370); ±39 amps (AVR 2700/AVR 270)
Transient intermodulation distortion (TIM):	Unmeasurable
Slew rate:	40V/μsec

### FM Tuner Section

Frequency range:	87.5 – 108.0MHz
Usable sensitivity IHF:	1.3μV/13.2dBf
Signal-to-noise ratio (mono/stereo):	70dB/68dB
Distortion (mono/stereo):	0.2%/0.3%
Stereo separation:	40dB @ 1kHz
Selectivity (±400kHz):	70dB
Image rejection:	80dB
IF rejection:	80dB

### AM Tuner Section

Frequency range:	520 – 1710kHz (AVR 3700/AVR 2700) 522 – 1620kHz (AVR 370/AVR 270)
Signal-to-noise ratio:	38dB
Usable sensitivity (loop):	500μV
Distortion (1kHz, 50% mod):	1.0%
Selectivity (±10kHz):	30dB

### Video Section

Television format:	NTSC (AVR 3700/AVR 2700); PAL (AVR 370/AVR 270)
Input level/impedance:	1Vp-p/75 ohms
Output level/impedance:	1Vp-p/75 ohms
Video frequency response (composite video):	10Hz – 8MHz (–3dB)
HDMI:	Support up to 4k x 2k

### General Specifications

Power requirement:	120V AC/60Hz (AVR 3700/AVR 2700); 220V – 240V AC/50Hz – 60Hz (AVR 370/AVR 270)
Power consumption:	<0.5W (standby); 440W maximum (AVR 3700/AVR 370); 370W maximum (AVR 2700/AVR 270)
Dimensions (W x H x D):	17-5/16" x 6-1/2" x 17-1/8" (440mm x 165mm x 435mm)
Weight	(AVR 3700/AVR 370): 17.6 lb (8kg) (AVR 2700/AVR 270): 16.9 lb (7.7kg)

Depth measurement includes knobs, buttons and terminal connections.  
Height measurement includes feet and chassis.

## Appendix – Default settings, worksheets, remote product codes

**Table A1 – Recommended Source Component Connections**

Device Type	AVR Source	Digital Audio Connection	Analog Audio Connection	Video Connections
Cable TV, satellite TV, HDTV or other device that delivers television programs	Cable/SAT	HDMI 2	Analog 1 or 2	HDMI 2
DVD Audio/Video, SACD, Blu-ray Disc, HD-DVD player	Disc	HDMI 1	Analog 1 or 2	HDMI 1
Media Server, including Harman Kardon DMC 1000	Media Server	HDMI 4	Analog 1 or 2	HDMI 4
TV	TV	Optical 1	Analog 1 or 2	None
Video-game console	Game	HDMI 3	Analog 1 or 2	HDMI 3
Any audio or video device, e.g., CD player, camcorder, cassette deck	C (yellow) or D (blue)	Coaxial or Optical	Analog 1 or 2	Composite Video 1 or 2 (not used for audio-only devices)
Analog Recorder	Any	None	Analog 1 or 2 Inputs and Rec Out	Composite Video 2 Input and Monitor Output
iPod or iPhone	USB/iPod	USB	N/A	N/A
DVR	DVR	HDMI 5	Analog 1 or 2	HDMI 5

**Table A2 – Source Setting Defaults**

	Cable/Sat	Disc	Media Server	Radio	TV	Game	AUX	iPod/iPhone via USB	DVR	USB
Surround Modes (Auto Select)	Logic 7 Movie	Logic 7 Movie	Logic 7 Movie	Logic 7 Movie	Logic 7 Movie	Logic 7 Movie	Logic 7 Music	Logic 7 Movie	Logic 7 Movie	Logic 7 Movie
Video Input	HDMI 2	HDMI 1	HDMI 4	N/A	N/A	HDMI 3	HDMI Front	N/A	HDMI 5	N/A
Audio Input	HDMI 2	HDMI 1	HDMI 4	N/A	Optical Digital Audio 1	HDMI 3	HDMI Front	N/A	HDMI 5	N/A
Resolution to Display*	480i (NTSC); 576p (PAL)	480i (NTSC); 576p (PAL)	480i (NTSC); 576p (PAL)	480i (NTSC); 576p (PAL)	480i (NTSC); 576p (PAL)	480i (NTSC); 576p (PAL)	480i (NTSC); 576p (PAL)	N/A	480i (NTSC); 576p (PAL)	480i (NTSC); 576p (PAL)
Zone 2 Audio	—	—	—	Radio	—	—	—	—	—	USB
Dolby Volume	Medium	Low	Medium	Medium	Medium	Medium	Low	Medium	Medium	Medium

\* Video output resolution may vary for HDMI connections. The default HDMI resolution is 1080i for NTSC and PAL.

**Table A3 – Speaker/Channel Setting Defaults**

	<b>All Digital and Two-Channel Analog Audio Input Connectors</b>	<b>Your Settings Position 1</b>	<b>Your Settings Position 2</b>
Left/Right Speakers	ON		
Center Speaker	ON		
Left/Right Surround Speakers	ON		
Left/Right Surround Back Speakers	OFF		
Subwoofer 1	ON		
Subwoofer 2	ON		
Left/Right Speakers Crossover Frequency	100Hz		
Center Speaker Crossover Frequency	100Hz		
Left/Right Surround Speakers Crossover Frequency	100Hz		
Left/Right Surround Back or Left/Right Front Height Speakers Crossover Frequency	100Hz		
Subwoofer Mode	LFE		
Subwoofer Size	100Hz		
Front Left Level	0dB		
Center Level	0dB		
Front Right Level	0dB		
Surround Right Level	0dB		
Surround Back Right/Front Height Right Level	0dB		
Surround Back Left/Front Height Left Level	0dB		
Surround Left Level	0dB		
Sub Level	0dB		

**Table A4 – Delay Setting Defaults**

<b>Speaker Position</b>	<b>Distance From Speaker to Listening Position</b>	<b>Your Delay Settings Position 1</b>	<b>Your Delay Settings Position 2</b>
Front Left	10 feet (3 meters)		
Center	10 feet (3 meters)		
Front Right	10 feet (3 meters)		
Surround Right	10 feet (3 meters)		
Surround Left	10 feet (3 meters)		
Surround Back Right/Front Height Right	10 feet (3 meters)		
Surround Back Left/Front Height Left	10 feet (3 meters)		
Subwoofer	10 feet (3 meters)		
A/V Lip Sync Delay (See Info Settings Menu)	0mS		



**Table A5 – Source Settings**

	Cable/ Sat	Disc	Media Server	Radio	TV	USB	Network	Game	AUX	iPod	DVR
Device Type						USB				iPod/iPhone	
Surround Modes											
Video Input						N/A				N/A	
Audio Input						USB				N/A	
Resolution to Display											
Adjust Lip Sync											
Change Name						N/A				N/A	
Zone 2 Audio						USB					
Dolby Volume											

**Table A6 – Audio Effects Settings**

	Default	Cable/Sat	Disc	Media Server	Radio	TV	USB	Network	Game	AUX	iPod	DVR
Dolby Volume	See Source											
Tone Control	On											
Treble	0dB											
Bass	0dB											
LFE Trim	0dB											

**Table A7 – Video Modes Settings**

	Default	Cable/ Sat	Disc	Media Server	Radio	TV	USB	Network	Game	AUX	iPod	DVR
Video Mode	Off											
Brightness*	50											
Contrast*	50											
Color*	50											
Sharpness*	50											
Noise Reduction**	Off											
MPEG Noise Reduction**	Off											
Cross Color Suppressor**	Off											
Film Mode Detect**	Off											

\* Note: These settings are available only when the Video Mode is set to Custom.

\*\* Note: These settings are displayed only when Advanced Video Settings is selected.

**Table A8 – Surround Modes**

	Default	Cable/ Sat	Disc	Media Server	Radio	TV	USB	Network	Game	AUX	iPod	DVR
Auto Select	Logic 7 Movie or native digital format											
Virtual Surround	HARMAN virtual speaker											
Stereo	7 CH Stereo											
Movie	Logic 7 Movie											
Music	Logic 7 Music											
Game	Logic 7 Game											
Center Width*	3											
Dimension*	0											
Panorama*	Off											

\* Note: These settings are available only when Dolby Pro Logic II or IIx Music mode has been selected. Access these settings by selecting the Edit option.

**Table A9 – Remote Control Codes**

Source Input	Device Type (if changed)	Product Brand and Code Number
Cable/Sat		
Disc		
DVR		
Media Server		
TV		
Game		
AUX		

**Table A10 – System Settings**

Feature	Default	Your Settings
Front Panel Dimmer	On 100%	
HDMI Audio to TV	Off	
HDMI Control	Off	
Audio Return Channel	Off	
CEC Power Control	Off	
TV Control	Off	
Network Settings	Automatic	
Volume Units	dB	
Volume Default	Off	
Volume Default Level	-25dB	
Unit of Measure	Feet (AVR 3700/AVR 2700); Meters (AVR 370/AVR 270)	
Language	English	
Dolby Volume Calibration	0dB	
RS232 Control	Off	
Menu Transparency	Medium	
Volume/Status Messages	3 Seconds	
Menus	1 minute	
Setup and Slide-In Menus	5 minutes	
Screen Saver	10 minutes	
Software Version	Check your unit	

**Table A11 – Zone 2 Settings**

Source Input	Default	Your Settings
Status	Off	
Source	Cable/Sat	
Volume	-25dB	
Assigned AMP	Surround Back	

**Table A12 – Surround Modes**

Surround Mode	Description	Incoming Bitstream or Signal
Dolby Digital	Provides up to five separate main audio channels and a dedicated low-frequency effects (LFE) channel.	<ul style="list-style-type: none"> <li>• Dolby Digital 1/0/.0 or .1, 2/0/.0 or .1, 3/0/.0 or .1, 2/1/.0 or .1, 2/2/.0 or .1, 3/2/.0 or .1</li> <li>• Dolby Digital EX (played as 5.1)</li> <li>• Dolby Digital Plus decoded and delivered via coaxial or optical connection</li> </ul>
Dolby Digital EX	An expansion of Dolby Digital 5.1 that adds a surround back channel that may be played through one or two surround back speakers. May be manually selected when a non-EX Dolby Digital stream is detected.	<ul style="list-style-type: none"> <li>• Dolby Digital EX</li> <li>• Dolby Digital 2/2/.0 or .1, 3/2/.0 or .1</li> </ul>
Dolby Digital Plus	An enhanced version of Dolby Digital encoded more efficiently, Dolby Digital Plus has the capacity for additional discrete channels and for streaming audio from the Internet, all with enhanced audio quality. Source material may be delivered via an HDMI connection or decoded to Dolby Digital or PCM and transmitted via coaxial or optical digital audio.	<ul style="list-style-type: none"> <li>• Dolby Digital Plus via HDMI connection (source device decodes to Dolby Digital when a coaxial or optical connection is used)</li> </ul>
Dolby TrueHD	Dolby TrueHD is an expansion of MLP Lossless™ audio, the same format used on DVD-Audio discs. Dolby TrueHD adds the features found in Dolby Digital, such as night mode settings, while delivering fully lossless audio that is a true reproduction of studio master recordings.	<ul style="list-style-type: none"> <li>• Blu-ray Disc or HD-DVD encoded with Dolby TrueHD, delivered via HDMI</li> </ul>
Dolby Digital Stereo	Delivers a two-channel downmix of Dolby Digital materials.	<ul style="list-style-type: none"> <li>• Dolby Digital 1/0/.0 or .1, 2/0/.0 or .1, 3/0/.0 or .1, 2/1/.0 or .1, 2/2/.0 or .1, 3/2/.0 or .1</li> <li>• Dolby Digital EX</li> </ul>
Dolby Pro Logic II Mode Group	Analog decoder that derives five full-range, discrete main audio channels from matrix surround-encoded or two-channel analog sources. Four variants are available.	See below
Dolby Pro Logic II Movie	Variant of Dolby Pro Logic II that is optimized for movie and television programs.	<ul style="list-style-type: none"> <li>• Dolby Digital 2.0 or 2.1</li> <li>• Analog (two-channel)</li> <li>• Tuner</li> <li>• PCM (32kHz, 44.1kHz, 48kHz, 96kHz)</li> </ul>
Dolby Pro Logic II Music	Variant of Dolby Pro Logic II that is optimized for music selections. Allows adjustment of sound-field presentation in three dimensions: <ul style="list-style-type: none"> <li>• Center Width (adjusts width of vocal soundstage)</li> <li>• Dimension (adjusts depth of soundstage)</li> <li>• Panorama (adjusts wraparound surround effect)</li> </ul>	<ul style="list-style-type: none"> <li>• Dolby Digital 2.0 or 2.1</li> <li>• Analog (two-channel)</li> <li>• Tuner</li> <li>• PCM (32kHz, 44.1kHz, 48kHz, 96kHz)</li> </ul>
Dolby Pro Logic	Variant of Dolby Pro Logic II that emphasizes use of the surround channels and subwoofer for total immersion in the video gaming experience.	<ul style="list-style-type: none"> <li>• Dolby Digital 2.0 or 2.1</li> <li>• Analog (two-channel)</li> <li>• Tuner</li> <li>• PCM (32kHz, 44.1kHz, 48kHz, 96kHz)</li> </ul>
Dolby Pro Logic II Game	Original version of Dolby Pro Logic that steered a mono signal containing information below 7kHz to the surround channels.	<ul style="list-style-type: none"> <li>• Dolby Digital 2.0 or 2.1</li> <li>• Analog (two-channel)</li> <li>• Tuner</li> <li>• PCM (32kHz, 44.1kHz, 48kHz, 96kHz)</li> </ul>
Dolby Pro Logic IIx Mode Group	An expansion of Dolby Pro Logic II that adds a surround back channel which may be played through one or two surround back speakers. The Dolby Pro Logic IIx modes may be selected not only with Dolby Digital bitstreams, but thanks to the AVR's post-processor, they may also be used with some DTS bitstreams to add a surround back channel to 5.1 modes.	See below

**Table A12 – Surround Modes – continued**

Surround Mode	Description	Incoming Bitstream or Signal
Dolby Pro Logic IIx Music	This mode is similar to Dolby Pro Logic II Movie, with an added surround back channel.	<ul style="list-style-type: none"> <li>• Dolby Digital 2/0/.0 or .1, 2/2/.0 or .1, 3/2/.0 or .1, EX</li> <li>• Analog (two-channel)</li> <li>• Tuner</li> <li>• PCM (32kHz, 44.1kHz, 48kHz, 96kHz)</li> </ul>
Dolby Pro Logic IIx Music	This mode is similar to Dolby Pro Logic II Music, including the availability of center width, dimension and panorama adjustments. Dolby Pro Logic IIx Music adds a surround back channel.	<ul style="list-style-type: none"> <li>• Dolby Digital 2/0/.0 or .1, 2/2/.0 or .1, 3/2/.0 or .1, EX</li> <li>• Analog (two-channel)</li> <li>• Tuner</li> <li>• PCM (32kHz, 44.1kHz, 48kHz, 96kHz)</li> </ul>
Dolby Pro Logic IIx Game	This mode is similar to Dolby Pro Logic II Game, with the added benefit of a surround back channel.	<ul style="list-style-type: none"> <li>• Dolby Digital 2/0/.0 or .1</li> <li>• Analog (two-channel)</li> <li>• Tuner</li> <li>• PCM (32kHz, 44.1kHz or 48kHz)</li> </ul>
Dolby Pro Logic IIz	An expansion of Dolby Pro Logic II that adds left and right front height channels that are played through two front height speakers mounted above and outside of the front left and right speakers.	<ul style="list-style-type: none"> <li>• Dolby Digital 2/0/.0 or .1, 2/2/.0 or .1, 3/2/.0 or .1, EX</li> <li>• Analog (two-channel)</li> <li>• Tuner</li> <li>• PCM (32kHz, 44.1kHz, 48kHz, 96kHz)</li> </ul>
HARMAN virtual speaker	Simulates 5.1 channels when only two speakers are present or a more enveloping sound field is desired.	<ul style="list-style-type: none"> <li>• Dolby Digital</li> <li>• Analog (two-channel)</li> <li>• Tuner</li> <li>• PCM (32kHz, 44.1kHz or 48kHz)</li> </ul>
DTS Digital	Using a different encoding/decoding method than Dolby Digital, DTS Digital also provides up to five discrete main channels, plus an LFE channel.	<ul style="list-style-type: none"> <li>• DTS 1/0/.0 or .1, 2/0/.0 or .1, 3/0/.0 or .1, 3/1/.0 or .1, 2/2/.0 or .1, 3/2/.0 or .1</li> <li>• DTS-ES Matrix (played as 5.1)</li> <li>• DTS-ES Discrete (played as 5.1)</li> </ul>
DTS-HD	DTS-HD is a new high-definition audio format that complements the high-definition video found on Blu-ray Disc and HD-DVD discs. It is transmitted using a DTS core with high-resolution extensions. Even when only DTS 5.1 surround sound is desired (or available, if the multizone system is in use), the higher capacity of high-resolution discs serves up DTS at twice the bit rate used on DVD-Video discs.	<ul style="list-style-type: none"> <li>• Blu-ray Disc or HD-DVD discs encoded with DTS-HD modes, delivered via HDMI connection</li> </ul>
DTS-HD Master Audio	DTS-HD Master Audio technology delivers bit-for-bit reproductions of the studio master recording in up to 7.1 channels for an incredibly accurate performance.	<ul style="list-style-type: none"> <li>• Blu-ray Disc or HD-DVD discs encoded with DTS-HD Master Audio technology, delivered via HDMI connection</li> </ul>
DTS-ES Matrix	DTS Extended Surround adds a single surround back channel to DTS 5.1 digital surround sound. The Matrix version includes the surround back channel information “matrixed” into the left and right (side) surround channels for compatibility with 5.1-channel systems.	<ul style="list-style-type: none"> <li>• DTS-ES Matrix</li> </ul>
DTS-ES Discrete	DTS-ES Discrete is another Extended Surround mode that adds a surround back channel, but this information is encoded discretely on the disc and is not derived from information contained in the surround channels.	<ul style="list-style-type: none"> <li>• DTS-ES Discrete</li> </ul>
DTS Stereo	Delivers a two-channel downmix of DTS Digital materials or presents a matrix-encoded surround presentation.	<ul style="list-style-type: none"> <li>• DTS 1/0/.0 or .1, 2/0/.0 or .1, 3/0/.0 or .1, 3/1/.0 or .1, 2/2/.0 or .1, 3/2/.0 or .1</li> <li>• DTS 96/24</li> <li>• DTS-ES Matrix</li> <li>• DTS-ES Discrete</li> </ul>

**Table A12 – Surround Modes – continued**

Surround Mode	Description	Incoming Bitstream or Signal
DTS Neo:6 Mode Group	DTS Neo:6 analog processing is available with DTS and DTS 96/24 signals and two-channel analog or PCM signals to create a 3-, 5- or 6-channel presentation.	See below
DTS Neo:6 Cinema	Depending on the number of speakers in your system, select 3-, 5- or 6-channel modes, enhanced for movie or video presentations.	<ul style="list-style-type: none"> <li>• DTS 2/2/.0 or .1, 3/2/.0 or .1</li> <li>• DTS 96/24</li> <li>• Analog (two-channel)</li> <li>• PCM (32kHz, 44.1kHz or 48kHz)</li> </ul>
DTS Neo:6 Music	Available only in 5- and 6-channel modes, creates a surround presentation suitable for music recordings.	<ul style="list-style-type: none"> <li>• DTS 2/2/.0 or .1, 3/2/.0 or .1</li> <li>• DTS 96/24</li> <li>• Analog (two-channel)</li> <li>• PCM (32kHz, 44.1kHz or 48kHz)</li> </ul>
Logic 7 Mode Group	A HARMAN proprietary technology, Logic 7 technology enhances two-channel and matrix-encoded recordings by deriving separate information for the surround back channels. It provides more accurate placement of sound, improves panning and expands the sound field, even when used with 5.1-channel systems. Logic 7 technology uses 96kHz processing and is available in 5.1- or 7.1-channel modes. Three variants are available.	See below
Logic 7 Movie	Especially suited to two-channel sources containing Dolby Surround or matrix encoding, Logic 7 Movie mode increases center-channel intelligibility. The AVR is programmed at the factory to default to this mode for two-channel signals.	<ul style="list-style-type: none"> <li>• Analog (two-channel)</li> <li>• Tuner</li> <li>• PCM (32kHz, 44.1kHz, 48kHz, 96kHz)</li> </ul>
Logic 7 Music	Logic 7 Music mode is well suited to conventional two-channel music recordings.	<ul style="list-style-type: none"> <li>• Analog (two-channel)</li> <li>• Tuner</li> <li>• PCM (32kHz, 44.1kHz, 48kHz, 96kHz)</li> </ul>
Logic 7 Game	Use Logic 7 Game mode to enhance enjoyment of video-game consoles.	<ul style="list-style-type: none"> <li>• Analog (two-channel)</li> <li>• Tuner</li> <li>• PCM (32kHz, 44.1kHz, 48kHz, 96kHz)</li> </ul>
5-Channel Stereo	Useful for parties, the left- and right-channel information is played through both the front and surround speakers on each side, while the center speaker plays a summed mono mix.	<ul style="list-style-type: none"> <li>• Analog (two-channel)</li> <li>• Tuner</li> <li>• PCM (32kHz, 44.1kHz, 48kHz, 96kHz)</li> </ul>
7-Channel Stereo	Expands the 5-Channel Stereo presentation to include the surround back channels.	<ul style="list-style-type: none"> <li>• Analog (two-channel)</li> <li>• Tuner</li> <li>• PCM (32kHz, 44.1kHz, 48kHz, 96kHz)</li> </ul>
2-Channel Stereo	Turns off all surround processing and plays a pure two-channel signal or a downmix of a multichannel signal. The signal is digitized and bass management settings are applied, making it appropriate when a subwoofer is used.	<ul style="list-style-type: none"> <li>• Analog (two-channel; DSP downmix available for multichannel)</li> <li>• Tuner</li> <li>• PCM (32kHz, 44.1kHz, 48kHz, 96kHz)</li> </ul>

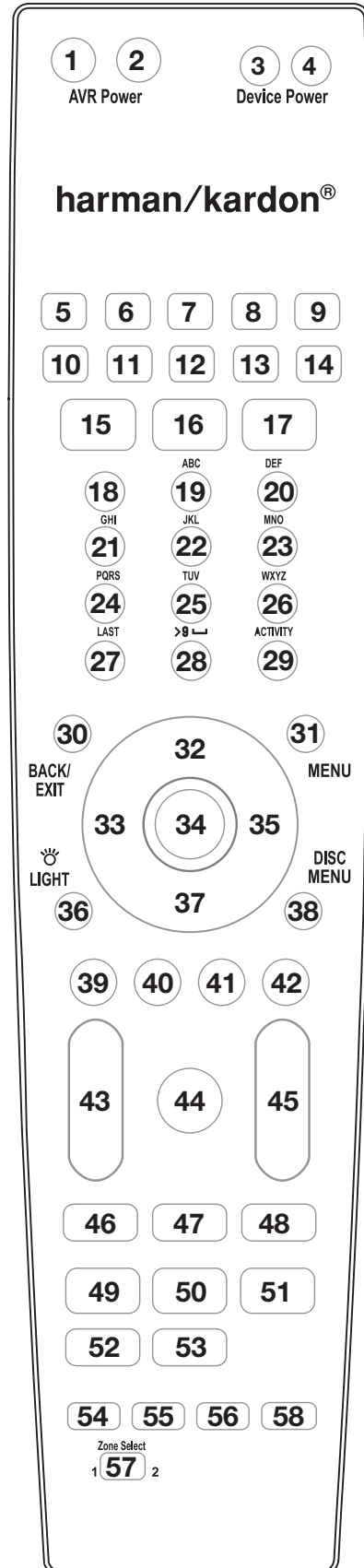

Refer to the numbered buttons when using the Function List in Table A13.

Remote Control Function List Reference

## Table A13 – Remote Control Function List

No.	Button Name	AVR	Radio		NETWORK/TUNER	Blu-ray/DVD	Media Server DMC1000	TV	USB/iPod
			FM	AM					
01	AVR Power On	AVR Power On	AVR Power On	AVR Power On	AVR Power On	AVR Power On	AVR Power On	AVR Power On	AVR Power On
02	AVR Power Off	AVR Power Off	AVR Power Off	AVR Power Off	AVR Power Off	AVR Power Off	AVR Power Off	AVR Power Off	AVR Power Off
03	Device Power On					Power On	On	Power On	
04	Device Power Off					Power Off	Off	Power Off	
05	Cable/Sat	Input Sel	Input Sel	Input Sel	Input Sel	Input Sel	Input Sel	Input Sel	Input Sel
06	Disc	Input Sel	Input Sel	Input Sel	Input Sel	Input Sel	Input Sel	Input Sel	Input Sel
07	DVR	Input Sel	Input Sel	Input Sel	Input Sel	Input Sel	Input Sel	Input Sel	Input Sel
08	Radio	Radio	Radio	Radio	Radio	Radio	Radio	Radio	Radio
09	TV	Input Sel	Input Sel	Input Sel	Input Sel	Input Sel	Input Sel	Input Sel	Input Sel
10	USB	Input Sel	Input Sel	Input Sel	Input Sel	Input Sel	Input Sel	Input Sel	Input Sel
11	Game	Input Sel	Input Sel	Input Sel	Input Sel	Input Sel	Input Sel	Input Sel	Input Sel
12	Media Server	Input Sel	Input Sel	Input Sel	Input Sel	Input Sel	Input Sel	Input Sel	Input Sel
13	Network	Input Sel	Input Sel	Input Sel	Input Sel	Input Sel	Input Sel	Input Sel	Input Sel
14	AUX	Input Sel	Input Sel	Input Sel	Input Sel	Input Sel	Input Sel	Input Sel	Input Sel
15	Audio Effects	Audio Effects	Audio Effects	Audio Effects	Audio Effects	Audio Effects	Audio Effects	Audio Effects	Audio Effects
16	Video Effects	Video Effects	Video Effects	Video Effects	Video Effects	Video Effects	Video Effects	Video Effects	Video Effects
17	Surround Modes	Surround Modes	Surround Modes	Surround Modes	Surround Modes	Surround Modes	Surround Modes	Surround Modes	Surround Modes
18	1	1	1	1	1	1	1	1	1
19	2	2	2	2	2	2	2	2	2
20	3	3	3	3	3	3	3	3	3
21	4	4	4	4	4	4	4	4	4
22	5	5	5	5	5	5	5	5	5
23	6	6	6	6	6	6	6	6	6
24	7	7	7	7	7	7	7	7	7
25	8	8	8	8	8	8	8	8	8
26	9	9	9	9	9	9	9	9	9
27	Last	Last	Last	Last	Last			Prev. Ch	Last
28	0	0	0	0	0	0	0	0	0
29	Activity	Activity	Activity	Activity	Activity	Activity	Activity	Activity	Activity
30	Back/Exit	Back/Exit	Back/Exit	Back/Exit	Back/Exit	Clear	Back		Back/Exit
31	Menu	Menu	Menu	Menu	Menu	Menu	Menu	Menu	Menu
32	Up	Up	Tune Up	Tune Up	Up	Up	Up	Up	Up
33	Left	Left	Preset/Down	Preset/Down	Left	Left	Left	Left	Left
34	OK	OK	OK	OK	OK	Enter	Enter	OK	OK
35	Right	Right	Preset/Up	Preset/Up	Right	Right	Right	Right	Right
36*	Light	Light	Light	Light	Light	Light	Light	Light	Light
37	Down	Down	Tune Down	Tune Down	Down	Down	Down	Down	Down
38	Disc Menu					Disc Menu	Disc Menu		
39	A (red)				Source A	Angle	Angle		
40	B (green)				Source B	Subtitle	Subtitle		
41	C (yellow)				Source C	Audio	Audio		
42	D (blue)				Source D	Zoom	Zoom		
43	Volume +	Volume +	Volume +	Volume +	Volume +	Volume +	Volume +	Volume +	Volume +
	Volume –	Volume –	Volume –	Volume –	Volume –	Volume –	Volume –	Volume –	Volume –
44	Mute	AVR Mute	AVR Mute	AVR Mute	AVR Mute	AVR Mute	AVR Mute	AVR Mute	AVR Mute
45	Channel/Page Up	Channel/Preset Up	Preset Up	Preset Up	Down	Page Up		Channel Up	Page Up
	Channel/Page Down	Channel/Preset Down	Preset Down	Preset Down	Channel/Page Down	Page Down		Channel Down	Page Down
46	Previous				Prev. Step	Prev. Step	Previous		Previous
47	Pause				Pause	Pause	Pause		Pause
48	Next				Next Step	Next Step	Next Step		Next
49	Rew ◀◀				Rew ◀◀	Rew ◀◀	Rew ◀◀		Rew ◀◀
50	Play ▶				Play ▶	Play ▶	Play ▶		Play ▶
51	FF ▶▶				FF ▶▶	FF ▶▶	FF ▶▶		FF ▶▶
52	Record						Record		
53	Stop				Stop	Stop	Stop		Stop
54	AVR	AVR Sel and Setup	AVR Sel and Setup	AVR Sel and Setup	AVR Sel and Setup	AVR Sel and Setup	AVR Sel and Setup	AVR Sel and Setup	AVR Sel and Setup
55	Info Settings	Info Settings	Info Settings	Info Settings	Info Settings	Info Settings	Info Settings	Info Settings	Info Settings
56	Sleep	Sleep	Sleep	Sleep	Sleep	Sleep	Sleep	Sleep	Sleep
57	Zone Select	Zone Select	Zone Select	Zone Select	Zone Select	Zone Select	Zone Select	Zone Select	Zone Select
58*	Learn	Learn	Learn	Learn	Learn	Learn	Learn	Learn	Learn

56 \* AVR 3700/AVR 370 only.



**Table A13 – Remote Control Function List – continued**

No.	Button Name	Cable/SAT	Game	DVR			AUX	
				HDTV	PVD	TIVO	CD	VCR
01	AVR Power On	AVR Power On	AVR Power On	AVR Power On	AVR Power On	AVR Power On	AVR Power On	AVR Power On
02	AVR Power Off	AVR Power Off	AVR Power Off	AVR Power Off	AVR Power Off	AVR Power Off	AVR Power Off	AVR Power Off
03	Device Power On	Power On	Play	Power On	Power On	Power On	Power On	Power On
04	Device Power Off	Power Off	Stop	Power Off	Power Off	Power Off	Power Off	Power Off
05	Cable/Sat	Input Sel	Input Sel	Input Sel	Input Sel	Input Sel	Input Sel	Input Sel
06	Disc	Input Sel	Input Sel	Input Sel	Input Sel	Input Sel	Input Sel	Input Sel
07	DVR	Input Sel	Input Sel	Input Sel	Input Sel	Input Sel	Input Sel	Input Sel
08	Radio	Radio	Radio	Radio	Radio	Radio	Radio	Radio
09	TV	Input Sel	Input Sel	Input Sel	Input Sel	Input Sel	Input Sel	Input Sel
10	USB	Input Sel	Input Sel	Input Sel	Input Sel	Input Sel	Input Sel	Input Sel
11	Game	Input Sel	Input Sel	Input Sel	Input Sel	Input Sel	Input Sel	Input Sel
12	Media Server	Input Sel	Input Sel	Input Sel	Input Sel	Input Sel	Input Sel	Input Sel
13	Network	Input Sel	Input Sel	Input Sel	Input Sel	Input Sel	Input Sel	Input Sel
14	AUX	Input Sel	Input Sel	Input Sel	Input Sel	Input Sel	Input Sel	Input Sel
15	Audio Effects	Audio Effects	Audio Effects	Audio Effects	Audio Effects	Audio Effects	Audio Effects	Audio Effects
16	Video Modes	Video Modes	Video Modes	Video Modes	Video Modes	Video Modes	Video Modes	Video Modes
17	Surround Modes	Surround Modes	Surround Modes	Surround Modes	Surround Modes	Surround Modes	Surround Modes	Surround Modes
18	1	1	1	1	1	1	1	1
19	2	2	2	2	2	2	2	2
20	3	3	3	3	3	3	3	3
21	4	4	4	4	4	4	4	4
22	5	5	5	5	5	5	5	5
23	6	6	6	6	6	6	6	6
24	7	7	7	7	7	7	7	7
25	8	8	8	8	8	8	8	8
26	9	9	9	9	9	9	9	9
27	Last	Prev. Ch	Enter	Prev. Ch	Instant Replay	Enter/Last		
28	0	0	0	0	0	0	0	0
29	Activity	Activity	Activity	Activity	Activity	Activity	Activity	Activity
30	Back/Exit	Bypass	Clear	Exit/Cancel	Exit	Exit		Cancel
31	Menu	Menu	Start	Menu	Menu	Menu		Menu
32	Up	Up	Up	Up	Up	Up		Up
33	Left	Left	Left	Left	Left	Left		Left
34	OK	OK	Select	Enter	Setup	Select		Enter
35	Right	Right	Right	Right	Right	Right		Right
36*	Light	Light	Light	Light	Light	Light	Light	Light
37	Down	Down	Down	Down	Down	Down		Down
38	Disc Menu	OSD	DVD Menu	OSD	AV	TiVo		OSD
39	A (red)	Guide	●	Caption	Mark	Window	Open/Close	
40	B (green)	PPV	■	Fav. Ch	Repeat	Live TV	Random Play	
41	C (yellow)	Fav. Ch	▲	MTS	Jump Up	Slow	Repeat	
42	D (blue)	Music	X	Aspect	Jump Down	Skip	Intro Scan	
43	Volume +	Volume +	Volume +	Volume +	Volume +	Volume +	Volume +	Volume +
	Volume –	Volume –	Volume –	Volume –	Volume –	Volume –	Volume –	Volume –
44	Mute	AVR Mute	AVR Mute	AVR Mute	AVR Mute	AVR Mute	AVR Mute	AVR Mute
45	Channel/Page Up	Channel Up	Scan Up	Channel Up	Page Up	Channel Up	(+10)	Channel Up
	Channel/Page Down	Channel Down	Scan Down	Channel Down	Page Down	Channel Down	Disc Skip	Channel Down
46	Previous		Slow Down	Back	Prev. Step	Thumb Down	Skip Down	Scan Down
47	Pause		Pause	Pause	Pause	Pause	Pause	Pause
48	Next		Slow Up	Replay	Next Step	Thumb Up	Skip Up	Scan Up
49	Rew ◀◀		Prev.	Rew ◀◀	Rew ◀◀	Rew ◀◀	R. Search	Rew ◀◀
50	Play ▶		Play ▶	Play ▶	Play ▶	Play ▶	Play ▶	Play ▶
51	FF ▶▶		Next	FF ▶▶	FF ▶▶	FF ▶▶	F. Search	FF ▶▶
52	Record		Subtitle	Record	Record	Record	Time	Record
53	Stop		Stop	Stop	Stop	Stop	Stop	Stop
54	Setup	AVR Sel and Setup	AVR Sel and Setup	AVR Sel and Setup	AVR Sel and Setup	AVR Sel and Setup	AVR Sel and Setup	AVR Sel and Setup
55	Info Settings	Info Settings	Info Settings	Info Settings	Info Settings	Info Settings	Info Settings	Info Settings
56	Sleep	Sleep	Sleep	Sleep	Sleep	Sleep	Sleep	Sleep
57	Zone Select							
58*	Learn	Learn	Learn	Learn	Learn	Learn	Learn	Learn

\* AVR 3700/AVR 370 only.

Refer to Tables A14 through A24 when programming the codes for your components into the remote.

**Table A14 – Remote Control Product Codes: TV**

TV Manufacturer/Brand	Setup Code Number
ADMIRAL	192
ANAM	045 106 109 112 122
AOC	037 122 123 128
AUDIOVOX	012
BLAUPUNKT	084
BROKSONIC	205 206
CITIZEN	045 123 128 132
CONTEC	045
CRAIG	045 157 158 159
CROWN	045 132
CURTIS MATHES	123 128 132
DAEWOO	045 087 102 105 106 108 111 114 116 119 127 128 132
DAYTRON	128 132
DYNATECH	063
DYNEX	014
ELECTROHOME	115 132
EMERSON	045 123 128 132 139 157 158 159 162 205
FUJITSU	041 042
FUNAI	045
FUTURETECH	045
GE	029 087 121 123 128 133 145 159 163
GRUNDIG	193
HALL MARK	128
HARMAN KARDON	201
HITACHI	123 128 132 144 147
HYTEK	016
INKEL	120
JC PENNEY	115 123 128 132 145
JENSEN	019
JVC	079 087 134
KEC	045
KLH	006
KTV	045 123 132 162
LG/GOLDSTAR	002 013 101 110 122 128 132
LLOYTRON	172 173
LODGENET	069
LXI 077	145 148
MAGNAVOX	030 040 123 128 132 145 148
MARANTZ	115 123 148
MEMOREX	069 128
METZ	084
MGA	115 123 128
MITSUBISHI	077 115 123 128 160 167 168
MTC	175 176
NATIONAL	148 177 179 180 181 182
NEC	010 115 121 123 125
OLEVIA	007

TV Manufacturer/Brand	Setup Code Number
OPTONICA	077
ORION	207 208 209 210 211
PANASONIC	087 148 169
PHILCO	045 115 123 128 132 148
PHILIPS	033 034 035 036 123 128 132 145 148
PIONEER	024 123 128
POLAROID	003 004 005 006 043
PORTLAND	128 132
PROSCAN	133
PROTON	008 059 122 128 132 165
QUASAR	032 087
RADIO SHACK	045 128 132 180 196 197
RCA	021 115 123 128 133 145 161 163
REALISTIC	045 167 196
RUNCO	044 046 152 153
SAMPO	059 123 128
SAMSUNG	020 022 124 128 132 145
SANYO	026 054
SCOTT	045 128 132
SEARS	128 132 145
SHARP	077 128 132
SIEMENS	084
SIGNATURE	069
SONY	028 031 117 130 136 194 212
SOUNDESIGN	045 128
SYLVANIA	025 123 128 145 148
SYMPHONIC	184
TANDY	077
TATUNG	063
TECHNICS	181
TECHWOOD	128
TEKNIKA	045 069 115 123 128 132
TELERENT	069
TERA	156
THOMSON	190 191
TIVO	051 052 and See Table A24
TMK	128
TOSHIBA	063 129 202
TOTEVISION	132
VIDEO CONCEPTS	160
VIDTECH	128
VIEWSONIC	011 038 039 047
VIZIO	001 002
WARDS	069 128 132 148
WESTINGHOUSE	017 018 023
YAMAHA	123 128
YORK	128
ZENITH	069 090

**Table A15 – Remote Control Product Codes: AUX-HDTV**

TV Manufacturer/Brand	Setup Code Number
APEX	614 616
DISH NETWORK	612
LG	604
MAGNAVOX	607 608 609 610 611
MOTOROLA	605
RCA	601 612
SAMSUNG	603
TATUNG	618
TIVO	See Table A24
ZENITH	602 606 619

**Table A16 – Remote Control Product Codes: AUX-VCR**

VCR Manufacturer/Brand	Setup Code Number
AIWA	340
AKAI	348 408 409 426
AUDIO DYNAMICS	318 348
BROKSONIC	410 447
CANON	435 440
CAPEHART	394
CITIZEN	434
CRAIG	345 416
DAEWOO	317 394 404
DAYTRON	394
DBX	318 348
DYNATECH	340
EMERSON	313 340 342 410 412
FISHER	317
FUNAI	340
GE	376 395 424
HARMAN KARDON	302 303 318 349
HITACHI	340 348
JC PENNEY	318 345
JENSEN	348
JVC	318 348 411 432
KENWOOD	320 348
LG/GOLDSTAR	318 407
LLOYD	340
LXI	320 340
MAGNAVOX	340
MARANTZ	318
MEMOREX	317 320 340 352 353 354 376 442
MGA	349
MITSUBISHI	349 431
MULTITECH	340
NAD	439

VCR Manufacturer/Brand	Setup Code Number
NATIONAL	440
NEC	318 348
NORDMENDE	348
OPTIMUS	459
ORION	447
PANASONIC	425 450 467 472
PHILCO	340
PHILIPS	340 375
PORTLAND	394
PULSAR	376
QUASAR	301 425
RADIO SHACK	355 434 440 442 458 459
RCA	395 424 425 457 472
REALISTIC	317 320 340 345 459
SAMSUNG	345 351 395 405 409
SANSUI	348 416 447
SANYO	317 320
SCOTT	410 412
SEARS	317 320
SHARP	429 456
SONY	380 429
SOUNDESIGN	340
SYLVANIA	340
SYMPHONIC	340
TANDY	317 340
TEAC	340 348
TEKNIKA	340
THOMAS 340	
TIVO See Table A24	
TMK	313
TOSHIBA	412 455
TOTEVISION	345
UNITECH	345
VECTOR RESEARCH	318
VIDEO CONCEPTS	318 340
VIDEOSONIC	345
WARDS	340 345 412
YAMAHA	318 340 348
ZENITH	340 350 376 383

**Table A17 – Remote Control Product Codes: AUX-CD**

CD Manufacturer/Brand	Setup Code Number
ADCOM	063 069
AIWA	072 111 118 156 170
AKAI	050 177 184
AUDIO TECHNICA	053
AUDIOACCESS	125
AUDIOFILE	211
BSR	044
CALIFORNIA AUDIO	109
CAPETRONIC	070
CARRERA	087
CARVER	136 140 141 143 144 145 185 186
CASIO	117 166
CLARINETTE	166
DENON	187 188 213
EMERSON	052 093 108
FISHER	055 095
FUNAI	126
GE	164
HAITAI	099 214
HARMAN KARDON	001 002 025 054 190
HITACHI	093
INKEL	216
JC PENNEY	098 147
JENSEN	153
JVC	176 195 196
KENWOOD	030 062 078 079 148 151 176 178 181
LG/GOLDSTAR	016 087
LOTTE	108
LUXMAN	077 102
LXI	164
MAGNAVOX	039 113
MARANTZ	058 084 191 192 193
MCINTOSH	194
MCS	080 098
MITSUMI	152
MODULAIRE	166
NAD	013 074 197 198
NAKAMICHI	199 200 201
NEC	069
NIKKO	053 055
ONKYO	037 038 045 046 171 175 202 203
OPTIMUS	065 089 091 092 099 104 212
PANASONIC	075 109 119 158 183 204
PHILIPS	039 138 149 209
PIONEER	071 094 100 112 123 131 161 162 215
PROTON	210
RADIO SHACK	126 166 213

CD Manufacturer/Brand	Setup Code Number
RCA	024 081 093 150
REALISTIC	058 093 095 104 105 108 164 166
SANSUI	047 081 134 157 172
SANYO	033 082 095
SCOTT	108
SHARP	058 105 114 151 159 167 180 181
SHERWOOD	003 041 058 105 133
SONY	103 115 116 118 132 139 163 205 206 207 208 212 217
SOUNDSTREAM	124
SYMPHONIC	059 110
TAEKWANG	177
TEAC	011 058 085 086 106 107 110 121 137 146 154
THETA DIGITAL	039
TOSHIBA	013 074 097 151 155 173
VECTOR RESEARCH	087
VICTOR	120 130
WARDS	095
YAMAHA	019 031 053 061 135 169
YORK	166

**Table A18 – Remote Control Product Codes: DVD**

DVD Manufacturer/Brand	Setup Code Number
APEX DIGITAL	061
DENON	019 020 051
GE	003 004
HARMAN KARDON	001 002 032
JVC	006
LG/GOLDSTAR	005 010 055 064 066
MAGNAVOX	056
MARANTZ	059
MITSUBISHI	023
NAD	062
ONKYO	009 048
PANASONIC	008 024 030 044
PHILIPS	016 056
PIONEER	018 027 041 065
PROCEED	060
PROSCAN	003 004
RCA	003 004
SAMSUNG	017 053 054
SHARP	028
SONY	011 012 015 043 045
THOMSON	003 004
TOSHIBA	009 058 067
YAMAHA	030 063
ZENITH	005 055 064

**Table A19 – Remote Control Product Codes: SAT**

SAT Manufacturer/Brand	Setup Code Number
BIRDVIEW	425
CHANNEL MASTER	320 321 325 361
CHAPARRAL	315 316 451
CITOH	360
DIRECTV	309 310 314
DISH NETWORK	364
DRAKE	313 317 318 413 481
DX ANTENNA	331 352 379 483
ECHOSTAR	364 395 397 452 453 463 477 478 484 485
ELECTRO HOME	392
FUJITSU	324 329 334
GENERAL INSTRUMENT	303 311 323 365 403 454 468 474
HITACHI	304 455
HOUSTON TRACKER	463
HUGHES	305 306 437 489
JANIEL	366
JERROLD	454 468 484
LEGEND	453
MACOM	317 365 369 370 371
MAGNAVOX	461 473
MEMOREX	453
MITSUBISHI	307
MOTOROLA	312 319
NEXTWAVE	423
NORSAT	373
OPTIMUS	466
PACE	328 487
PANASONIC	353 366 457 469
PANSAT	420
PERSONAL CABLE	418
PHILIPS	375
PICO	407
PRESIDENT	381 404
RCA	301 358 439 458 465 490
REALISTIC	349 480
SAMSUNG	322 326 442
SATELLITE SERVICE CO	335 388
SCIENTIFIC ATLANTA	339 356
SONY	362 405
STAR CHOICE DBS	459
STARCAST	347
SUPER GUIDE	327 423
TELECOM	330 333 390 391 393 409
TOSHIBA	302 426 460 461 462 470
UNIDEN	323 332 348 349 350 351 354 355 381 383 389 403 466 479 480
ZENITH	359 384 385 387 394 419 488

**Table A20 – Remote Control Product Codes: Game**

GAME Manufacturer/Brand	Setup Code Number
Microsoft (XBOX, XBOX 360)	001 003
NYKO (PS3)	005
SONY (PS2, PS3)	002 004

**Table A21 – Remote Control Product Codes: Cable**

Cable Manufacturer/Brand	Setup Code Number
ABC	001 011
ALLEGRO	111
AMERICAST	212
ARCHER	112
BELCOR	113
CABLE STAR	033 113
CITIZEN	111
COMCAST	007
DIGI LINK	114
EAGLE	186
EASTERN	066 070
EMERSON	112
GENERAL INSTRUMENT	001 011 017 096 097 210
GC ELECTRONICS	113
GEMINI	032 060
HAMLIN	056 099 100 101 117 175 208
HITACHI	001 188
JASCO	111
JERROLD	001 002 011 017 073 096 097 162 188 210
LINSAY	118
MACOM	191
MAGNAVOX	017 019 068
MOVIE TIME	035 039
NSC	035 190
OAK	197 220
PACE	179
PANASONIC	053 176 177 189 214
PANTHER	114
PHILIPS	013 019 020 085 090
PIONEER	001 041 119 171 209 215 216
RADIO SHACK	111 112 213
RCA	053 214
RECOTON	116
REGAL	056 099 100 101 208
REMRANT	032
SAMSUNG	003 072 186
SCIENTIFIC ATLANTA	183 203 221 222
SEAM	121
SIGNATURE	001 188
SPRUCER	053 081 177 189

**Table A21 – Remote Control Product Codes: Cable – continued**

Cable Manufacturer/Brand	Setup Code Number
STARCOM	002 011 163
STARGATE	120
TANDY	024
TELECAPATION	028
TEXSCAN	036
TFC	122
TIVO	029 030 and See Table A24
TOCOM	170 205
UNITED CABLE	011
UNIVERSAL	033 034 039 042 113
VIDEOWAY	124 211
VIEWSTAR	019 025 053 086 089 190
ZENITH	065 125 211 219

**Table A24 – Remote Control Product Codes: AUX- TiVo**

Manufacturer/Brand	Setup Code Number
COMCAST TIVO	808
COX TIVO	808
DIRECTV TIVO	806
HUMAX TIVO	803
Nero LiquidTV TIVO	805
PIONEER TIVO	801
TIVO HD XL DVR	807
TIVO HD DVR	804
TIVO SERIES2™ DT DVR	802
TOSHIBA TIVO	803

**Table A22 – Remote Control Product Codes: Media Server**

Manufacturer/Brand	Setup Code Number
APPLE	008 009
BEYOND	003
ESCIENT (FIREBALL)	004 005 006 007
HARMAN KARDON	001 002
LOGITECH	012
MICROSOFT	003
NAIM	011
REQUEST	010
SONOS	013

**Table A23 – Remote Control Product Codes: AUX-Cable/SAT Recorder (PVR)**

Manufacturer/Brand	Setup Code Number
DAEWOO	701 704
EHOSTAR	714 715 716
EXPRESSVU	714
HUGHES	717 727
HYUNDAI	718
PANASONIC	710 723
PHILIPS	711 717 724 727
PROSCAN	719
RCA	719 727
REPLAYTV	708 710 712 725 726
SONICBLUE	710 712
SONY	707 713 720 721 722 723 724



## HARMAN

HARMAN Consumer, Inc.  
8500 Balboa Boulevard, Northridge, CA 91329 USA

© 2012 HARMAN International Industries, Incorporated. All rights reserved.

Harman Kardon and Logic 7 are trademarks of HARMAN International Industries, Incorporated, registered in the United States and/or other countries. EzSet/EQ is a trademark of HARMAN International Industries, Incorporated.

Blu-ray Disc is a trademark of the Blu-ray Disc Association.

CEA is a registered trademark of the Consumer Electronics Association.

DLNA is a registered trademark of the Digital Living Network Alliance.

Manufactured under license from Dolby Laboratories. Dolby, the double-D symbol and Pro Logic are registered trademarks of Dolby Laboratories. MLP Lossless is a trademark of Dolby Laboratories.

Manufactured under license under U.S. Patent #'s 5,451,942; 5,956,674; 5,974,380; 5,978,762; 6,226,616; 6,487,535; 7,003,467 and other U.S. and worldwide patents issued and pending. DTS, DTS-ES and DTS Neo:6 are registered trademarks, and DTS 96/24, DTS-HD, DTS-HD High Resolution Audio and DTS-HD Master Audio are trademarks, of DTS, Inc. © 1996-2007 DTS, Inc. All Rights Reserved.

HDMI, the HDMI logo and High-Definition Multimedia Interface are registered trademarks of HDMI Licensing LLC in the United States and other countries.

Intel is a registered trademark of Intel Corporation.

Apple, iPhone, iPod, iPod touch, iTunes and Macintosh are trademarks of Apple Inc., registered in the U.S. and other countries.

TiVo is a registered trademark of TiVo Inc. Series2 is a trademark of TiVo, Inc.

Windows Media is a registered trademark of Microsoft Corporation in the United States and/or other countries.

Features, specifications and appearance are subject to change without notice.

Part No. HKP4053 Rev. A

**harman/kardon**  
by HARMAN

[www.harmankardon.com](http://www.harmankardon.com)