

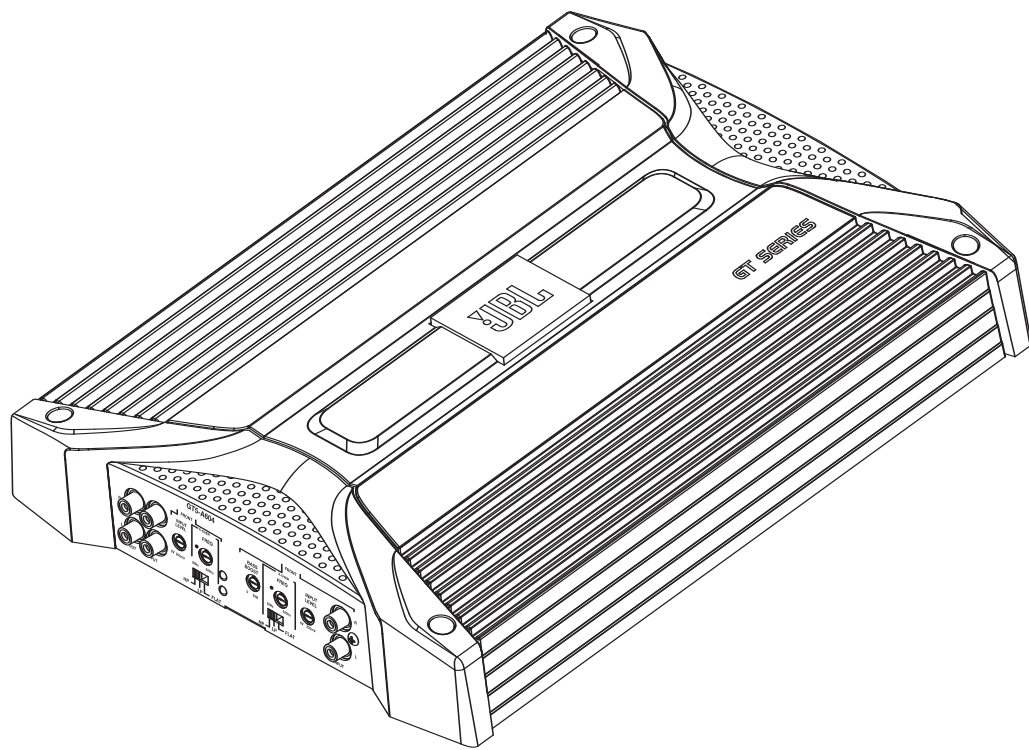

GT5-A604
OWNER'S MANUAL

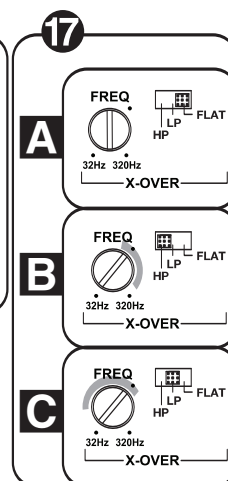

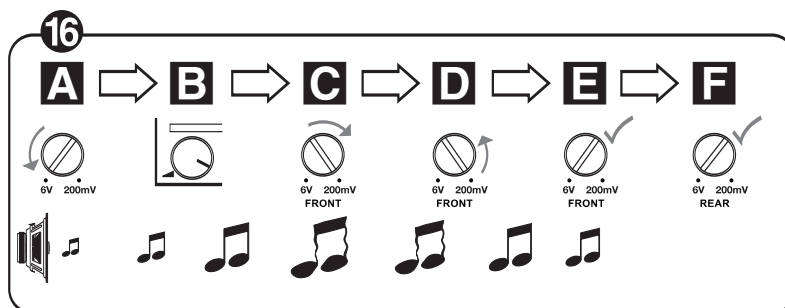
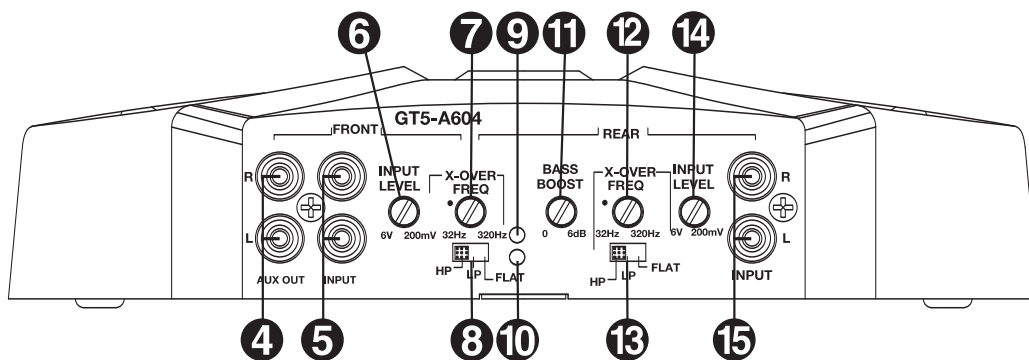
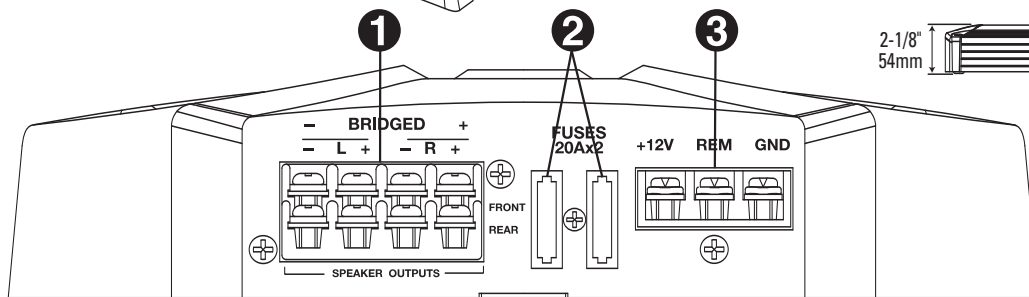
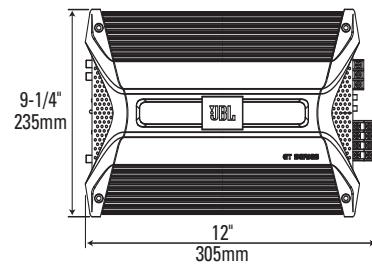
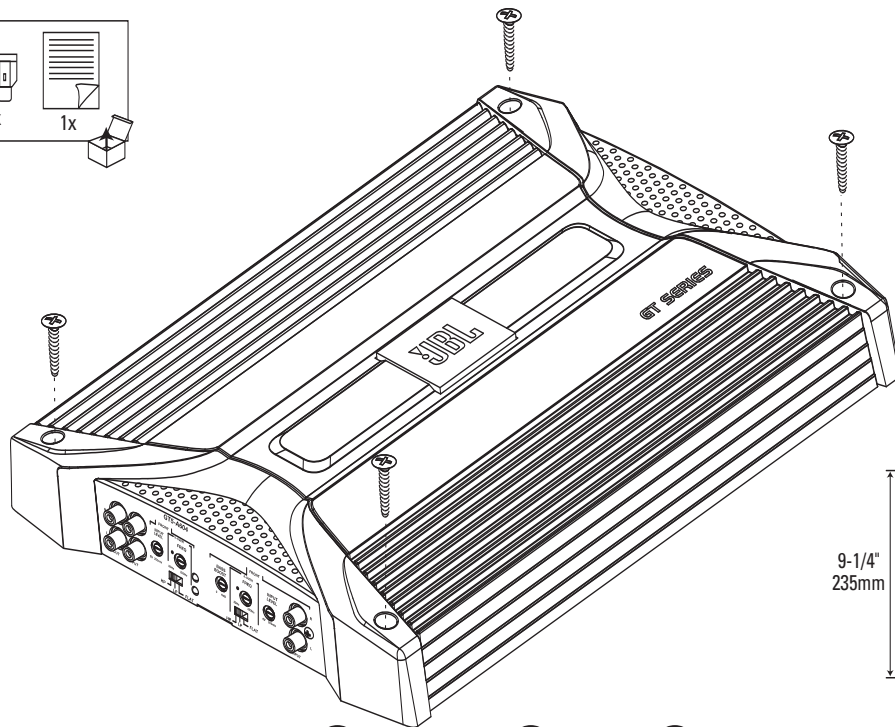
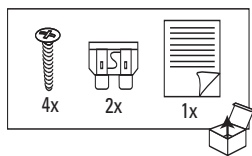

GT5-A604 CAR AUDIO POWER AMPLIFIER OWNER'S MANUAL

Installation Warnings and Tips

- Disconnect the negative (–) lead from your vehicle's battery.
- At the installation sites, locate and make a note of all fuel lines, hydraulic brake lines, vacuum lines and electrical wiring. Use extreme caution when cutting or drilling in and around these areas.
- Choose a safe mounting location away from moisture.
- Make sure there is sufficient air circulation at the mounting location for the amplifier to cool itself.
- Mount the amplifier, using the supplied hardware.

Specifications

- 60W RMS x 4 @ 4 ohms and $\leq 1\%$ THD + N*
 - 80W RMS x 4 @ 2 ohms, 14.4V supply and $\leq 1\%$ THD + N*
 - 160W RMS x 2 @ 4 ohms, 14.4V supply and $\leq 1\%$ THD + N*
 - Total peak power: 640 watts
 - Frequency response: 10Hz – 100kHz (–3dB)*
 - Maximum input signal: 6V*
 - Maximum sensitivity: 200mV*
 - THD + N: 0.05%
 - Signal-to-noise ratio: 85dB (reference 1W into 4 ohms)*
 - Signal-to-noise ratio: 102dB (reference rated power into 4 ohms)
- * CEA-2006A-compliant

1 Speaker Output Connectors

- Connect the speakers to these terminals, observing proper polarity:
 - Four-channel operation: Connect the front left speaker to the Front L+ and L– terminals, and the front right speaker to the Front R+ and R– terminals. Repeat for rear speakers, using the Rear L+ and L– terminals, and the Rear R+ and R– terminals.
 - Three-channel operation: Connect the stereo speakers to the Front terminals, as above. Connect the single speaker into which the amplifier's rear channels will be bridged to the Rear R+ and Rear L– terminals.
 - Two-channel (bridged) operation: Connect one speaker to the Front R+ and Front L– terminals. Connect the other speaker to the Rear R+ and Rear L– terminals.
- Minimum speaker impedance for stereo operation is 2 ohms. Minimum speaker impedance for bridged operation is 4 ohms.

2 Fuses

- Replace only with the same type and rating.

3 Power Input Connectors

- +12V: Connect to the positive terminal of the vehicle's battery. 8 AWG wire is recommended. Install an appropriate fuse holder and fuse (40A minimum) within 18 inches of the battery. Make sure the wire is not damaged or pinched during installation. Install protective grommets when routing wires through the firewall or other sheet metal.
- GND: Connect to the vehicle's chassis. Refer to the picture below.

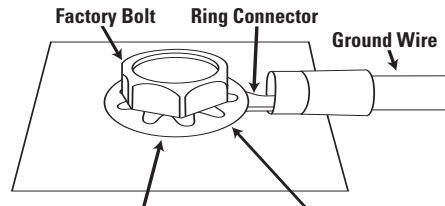

Note: Remove any paint below ring connector.

- REM: Connect to the "Remote Out" lead from the source unit or to a source of switched 12V+ (ACC).

4 Aux Output Connectors (RCA)

- Summed, nonfiltered pass-through output. Front right and rear right inputs are combined and sent to the right AUX output. Front left and rear left inputs are combined and sent to the left AUX output. Connect to the input of an additional subwoofer amplifier.

5 Front Input Connectors (RCA)

- Connect to the front RCA outputs from the source unit or signal processor.

6 Front Input-Level Control

- Used to match the front input level of the amplifier to the output level of the source unit.
- See 16 for the adjustment procedure.

7 Front Crossover-Frequency Control

- 12dB/octave crossover, variable from 32Hz to 320Hz.
- See 17 for the adjustment procedure.

8 Front Crossover-Filter Selector

- LP: Select for subwoofer(s).
- FLAT: Select for full-range speakers when no subwoofer will be used in the system.
- HP: Select for midrange speakers or full-range speakers when a subwoofer is used in the system.

9 Power On LED

- Illuminated when the amplifier is on.

10 Protect LED

- Illuminated under any of the following fault conditions: battery over/under voltage, short circuit in speaker wires, amplifier is too hot, amplifier's output circuit has failed (DC voltage present in the amplifier's output).

11 Rear Bass-Boost Control

- Provides up to 6dB of boost at 50Hz. Set the Bass-Boost control according to your preference, being careful not to apply enough boost to damage the speaker(s).

12 Rear Crossover-Frequency Control

- 12dB/octave crossover, variable from 32Hz to 320Hz.

- See adjustment procedure in 17.

13 Rear Crossover-Filter Selector

- LP: Select for subwoofer(s).
- FLAT: Select for full-range speakers when no subwoofer will be used in the system.
- HP: Select for midrange speakers or full-range speakers when a subwoofer is used in the system.

14 Rear Input-Level Control

- Used to match the rear input level of the amplifier to the output level of the source unit.
- See 16 for the adjustment procedure.

15 Rear Input Connectors (RCA)

- Connect to rear RCA outputs from the source unit or signal processor.

16 Setting Input Level

- A** Turn all Input-Level controls counterclockwise to 6V (minimum).
- B** With a dynamic music track playing, turn head unit's volume control to the 3/4 position.
- C** Turn Front Input-Level control clockwise until the music is so loud that it no longer sounds clear (distortion is present in the output).
- D** Turn Front-Input-Level control counterclockwise gradually, just until the music sounds clear, once again.
- E** Front-level input is now adjusted correctly.
- F** Adjust Rear Input-Level control so that the level of the rear speakers is proportionate to the level of the front speakers, according to your preference.

17 Setting the Crossover

- A** Crossover setting for 5" or larger full-range speakers when no subwoofer is included in the system.
- B** Crossover setting for midrange and/or full-range speakers when a subwoofer is included in the system.
- C** Crossover setting for subwoofers.

Note: Acceptable frequency ranges indicated in gray.

This product is designed for mobile applications and is not intended for connection to the mains. A valid serial number is required for warranty coverage. Features, specifications and appearance are subject to change without notice.



Harman Consumer Group, Inc.
250 Crossways Park Drive, Woodbury, NY 11797
www.jbl.com

© 2008 Harman International Industries, Incorporated. All rights reserved.

JBL is a trademark of Harman International Industries, Incorporated,
registered in the United States and/or other countries.

Part No. GT5A6040M 3/08

H A Harman International Company



Declaration of Conformity

CE

We, Harman Consumer Group, Inc.
2, route de Tours
72500 Château du Loir
France

declare in own responsibility that the product described in this owner's
manual is in compliance with technical standards:
EN 55013:2001+A1:2003
EN 55020:2002+A1:2003

Klaus Lebherz
Klaus Lebherz
Harman Consumer Group, Inc.
Château du Loir, France 3/08