



CINEMA SB590



OWNER'S MANUAL

IMPORTANT SAFETY INSTRUCTIONS

Verify Line Voltage Before Use

The JBL CINEMA BAR SB590 (soundbar and subwoofer) has been designed for use with 100-240 volt, 50/60 Hz AC current. Connection to a line voltage other than that for which your product is intended can create a safety and fire hazard and may damage the unit. If you have any questions about the voltage requirements for your specific model or about the line voltage in your area, contact your retailer or customer service representative before plugging the unit into a wall outlet.

Do Not Use Extension Cords

To avoid safety hazards, use only the power cord supplied with your unit. We do not recommend that extension cords be used with this product. As with all electrical devices, do not run power cords under rugs or carpets, or place heavy objects on them. Damaged power cords should be replaced immediately by an authorized service center with a cord that meets factory specifications.

Handle the AC Power Cord Gently

When disconnecting the power cord from an AC outlet, always pull the plug; never pull the cord. If you do not intend to use this speaker for any considerable length of time, disconnect the plug from the AC outlet.

Do Not Open the Cabinet

There are no user-serviceable components inside this product. Opening the cabinet may present a shock hazard, and any modification to the product will void your warranty. If water accidentally falls inside the unit, disconnect it from the AC power source immediately, and consult an authorized service center.

TABLE OF CONTENTS

IMPORTANT SAFETY INSTRUCTIONS 2

1. INTRODUCTION 4

2. WHAT'S IN THE BOX 5

3. PRODUCT OVERVIEW 6

- 3.1 Controls and indicators 6
 - 3.2 Connectors 6
 - 3.3 Subwoofer 6
 - 3.4 Remote control 7
-

4. PLACEMENT 8

- 4.1 Desktop placement 8
 - 4.2 Wall-mounting 8
-

5. CONNECT 9

- 5.1 Connection with your TV and digital devices 9
 - 5.2 Bluetooth connection 10
-

6. PLAY 11

- 6.1 Power-on/Auto standby/Auto wakeup 11
 - 6.2 Play from the TV source 11
 - 6.3 Play from the HDMI IN source 12
 - 6.4 Play from the Bluetooth source 12
-

7. SOUND SETTINGS 13

- 7.1 Dolby Atmos (Virtual) 13
- 7.2 Pre-defined EQ settings 13
- 7.3 Bass adjustment 13

8. RESTORE FACTORY SETTINGS 14

9. RE-CONNECT THE SUBWOOFER 14

10. PRODUCT SPECIFICATIONS 15

11. TROUBLESHOOTING 16

12. TRADEMARKS 17

1. INTRODUCTION

Thank you for purchasing the JBL CINEMA BAR SB590 (soundbar and subwoofer) which is designed to bring an extraordinary sound experience to your home entertainment system. We encourage you to take a few minutes to read through this manual, which describes the product and includes step-by-step instructions for setting up and getting started.

Designs and specifications are subject to change without notice. If you have any questions about the soundbar, installation or operation, please contact your retailer or customer service representative, or visit our website: www.jbl.com.

2. WHAT'S IN THE BOX

Unpack the box carefully and ensure that the following parts are included. If any part is damaged or missing, do not use it and contact your retailer or customer service representative.

Main unit



Subwoofer



Remote control (with 2 AAA batteries)

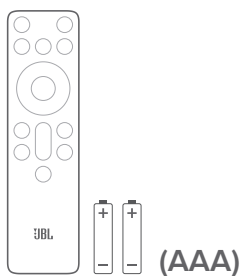

Power cord*

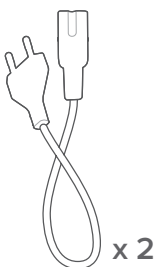

x 2

* Power cord quantity and plug type vary by regions.

HDMI cable

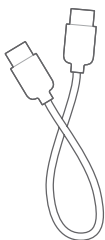

Wall-mounting kit



Product information & wall-mounting template



3. PRODUCT OVERVIEW

3.1 Controls and indicators

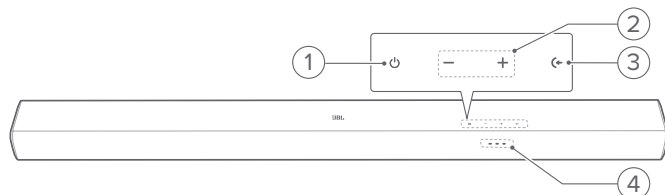

1. ⏻ (Power)

- Switch on or to standby.

2. +/- (Volume)

- Press to decrease or increase the volume.
- Hold to decrease or increase the volume continuously.
- Hold both buttons together to mute or unmute.

3. ↻ (Source)

- Select a sound source: TV (default, for audio input from TV connection where the **HDMI OUT (TV ARC/TV eARC)** connector is prioritized over the **OPTICAL (TV)** connector), **HDMI IN** or Bluetooth.
- In Bluetooth mode, hold for more than 3 seconds to enter Bluetooth pairing mode.

4. Status indicators

| | | |
|------------|---|--|
| ● (red) | Solid (red) | Standby mode |
| ● (red) | Fast flashing (red) | System startup |
| ○ (white) | Solid (white) | HDMI ARC source selected |
| ● (yellow) | Solid (yellow) | HDMI IN source selected |
| ● (amber) | Solid (amber) | Optical source selected |
| ● (blue) | Fast flashing (blue) | Bluetooth pairing mode |
| ● (blue) | Solid (blue) | Connected to Bluetooth |
| ● (green) | Solid (green) | Playing Dolby Atmos® audio |
| \ | Flashing (current sound source) | Adjusting volume level |
| \ | Slow flashing (current sound source) | Maximum / minimum volume level reached |
| \ | Continuous slow flashing (current sound source) | Sound muted |

3.2 Connectors

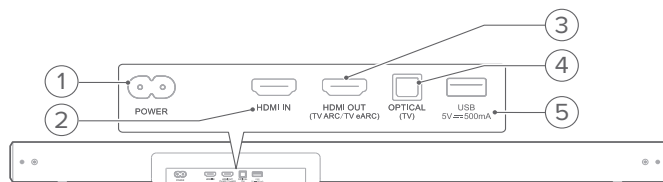

1. POWER

- Connect to power.

2. HDMI IN

- Connect to the HDMI output on your digital device.

3. HDMI OUT (TV ARC/TV eARC)

- Connect to the HDMI ARC/HDMI eARC input on your TV.

4. OPTICAL (TV)

- Connect to the optical output on your TV.

5. USB

- USB connector for software update (for service only).
- Connect to USB storage device for MP3 file playback (for US version only).

3.3 Subwoofer

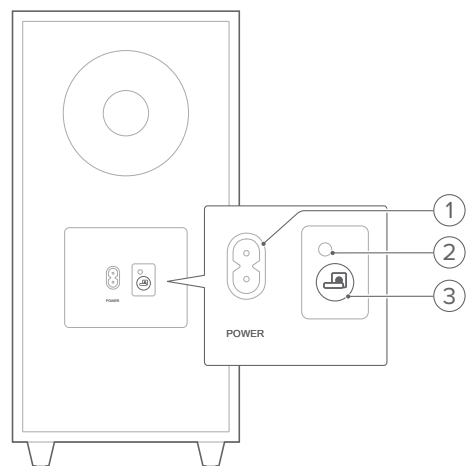

1. POWER

- Connect to power.

2. Connection status indicator

| | | |
|-----------|-----------------------|-----------------------------|
| ● (amber) | Solid amber | Connected to the soundbar |
| ● (amber) | Fast flashing (amber) | Pairing mode |
| ● (amber) | Slow flashing (amber) | Standby mode / Disconnected |

3. 🔌

- Hold for 3 seconds to reconnect the subwoofer with the soundbar.

3.4 Remote control

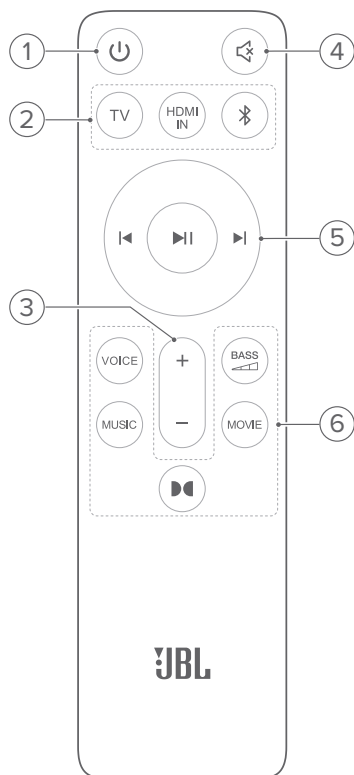

1.

- Switch on or to standby.

2. Source selectors

TV

- Select the TV source (automatically switches to eARC/ARC or Optical source when the HDMI / optical cable is connected; **HDMI OUT (TV ARC/TV eARC)** connector is prioritized over the **OPTICAL (TV)** connector).

HDMI IN

- Select the HDMI IN source.

(Bluetooth mode)

- Select the Bluetooth source.
- Hold for 3 seconds to enter Bluetooth pairing mode.

3. + / -

- Press to increase or decrease the volume.
- Hold to increase or decrease the volume continuously.

4. (Mute)

- Mute or unmute.

5. Playback buttons



- Bluetooth source: Skip to the previous or next track.



- Bluetooth source: Start or pause playback.

6. Sound effect buttons

VOICE

- Select the pre-defined EQ (equalizer) settings for news.

MUSIC

- Select the pre-defined EQ (equalizer) settings for music.

MOVIE

- Select the pre-defined EQ (equalizer) settings for movie.

BASS



- Select the bass level for subwoofer: 1/2/3 (default)/4/5



- Switch the virtual Dolby Atmos sound effects on or off (Default: on)

4. PLACEMENT

4.1 Desktop placement

Place the soundbar and subwoofer on a flat and stable surface. Make sure that the subwoofer is at least 1 m / 3 ft away from the soundbar, and 10 cm / 4" away from a wall.

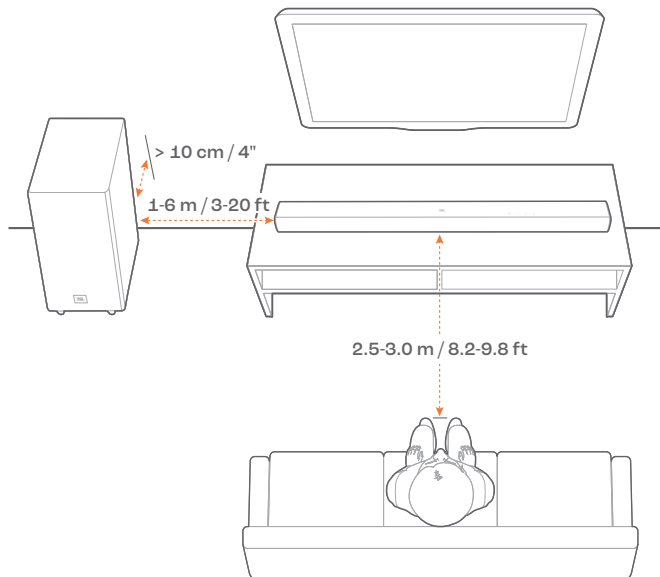

NOTES:

- The power cord shall be properly connected to power.
- Do not place any objects on the top of the soundbar or subwoofer.
- Make sure that the distance between the subwoofer and the soundbar is less than 6 m / 20 ft.

4.2 Wall-mounting

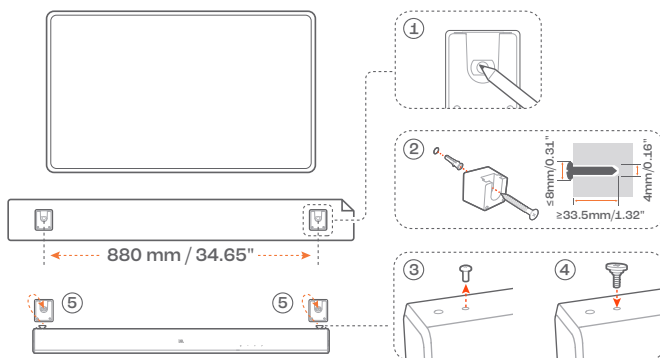

1. Preparation:
 - a) Stick the supplied wall-mounting template to a wall by using adhesive tapes.
 - b) Use your ballpen tip to mark the screw holder location. Remove the template.
 - c) On the marked location, drill a 4 mm / 0.16" hole. Refer to Figure 2 for the screw size.
2. Install the wall-mounting bracket.

3. As shown in the diagram, remove the fastening screw by using a screwdriver.
4. Fasten the wall-mounting screw included in the supplied mounting kit.
5. Mount the soundbar.

NOTES:

- Make sure that the wall can support the weight of the soundbar.
- Install on a vertical wall only.
- Avoid a location under high temperature or humidity.
- Before wall-mounting, make sure that cables can be properly connected between the soundbar and external devices.
- Before wall-mounting, make sure that the soundbar is unplugged from power. Otherwise, it may cause an electric shock.

5. CONNECT

5.1 Connection with your TV and digital devices

For audio playback through the soundbar, connect the soundbar with your TV through the supplied HDMI cable or an optical cable (sold separately).

An HDMI connection supports digital audio and video with a single connection. HDMI connectivity is the best option for your soundbar.

NOTES:

- When both HDMI and optical cables are connected to the soundbar for audio input from TV connection, the HDMI connection is prioritized.
- * The HDMI cable (for digital device connection) and the optical cable are sold separately.
- Full compatibility with all HDMI-CEC devices is not guaranteed.

5.1.1 TV (HDMI eARC)

(Recommended connection for the best Dolby Atmos experience)

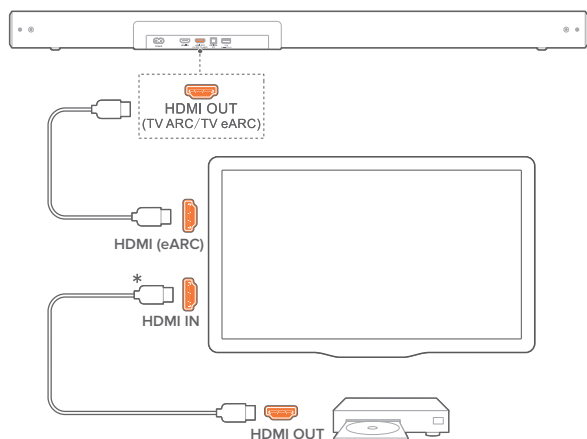

1. Connect the soundbar with the **HDMI (eARC)** connector on your TV by using the supplied HDMI cable.
 - On your TV, check that HDMI-CEC and HDMI eARC have been enabled. Refer to the owner's manual of your TV for more information.
2. Use an HDMI cable (V2.0 or later) to connect your TV with your digital device, such as a streaming device, set-top box, DVD / Blu-ray player or game console.
 - On your digital device, check that HDMI-CEC has been enabled. Refer to the owner's manual of your digital device for more information.
 - On your TV and digital device, select "Bitstream" or "Raw data" in the audio output settings for the best Dolby Atmos experience.

NOTES:

- To play audio from the digital device connected to your TV, select the TV source (See "[6.2 Play from the TV source](#)").
- With the Virtual Dolby Atmos design, the Dolby surround upmixer of the soundbar can expand the legacy channel-based audio of Dolby Digital format, including 5.1 and 7.1 content, and provide an immersive 3D Atmos experience.

5.1.2 TV (HDMI ARC)

1. Connect the soundbar with the **HDMI (ARC)** connector on your TV by using the supplied HDMI cable.
 - On your TV, check that HDMI-CEC and HDMI ARC have been enabled. Refer to the owner's manual of your TV for more information.
2. Use an HDMI cable (V2.0 or later) to connect the soundbar with your digital device, such as a set-top box, DVD / Blu-ray player or game console.
 - On your digital device, check that HDMI-CEC has been enabled. Refer to the owner's manual of your digital device for more information.
 - On your digital device, select "Bitstream" or "Raw data" in the audio output settings for the best Dolby Atmos experience.

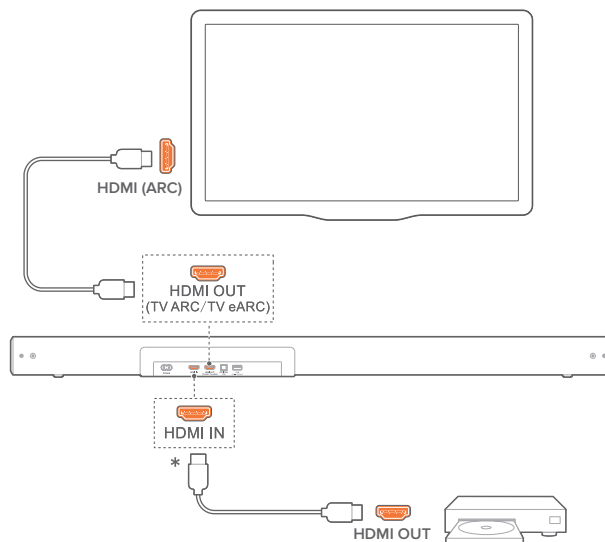

NOTES:

- To play audio from the digital device connected to the soundbar, select the HDMI IN source (See "[6.3 Play from the HDMI IN source](#)").
- If your TV does not support HDMI eARC, make sure that you connect your digital device through the **HDMI IN** connector on the soundbar instead of your TV. Otherwise, the Dolby Atmos information cannot pass through the **HDMI (ARC/eARC)** connectors to the soundbar.

5.1.3 OPTICAL

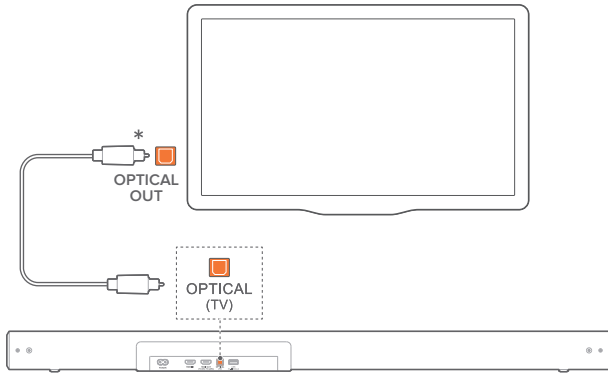

Connect the soundbar with your TV by using an optical cable.

NOTE:

- To play audio through the optical cable, select the TV source (See [“6.2 Play from the TV source”](#)).

5.2 Bluetooth connection

Through Bluetooth, connect the soundbar with your Bluetooth device, such as a smartphone, tablet and laptop.

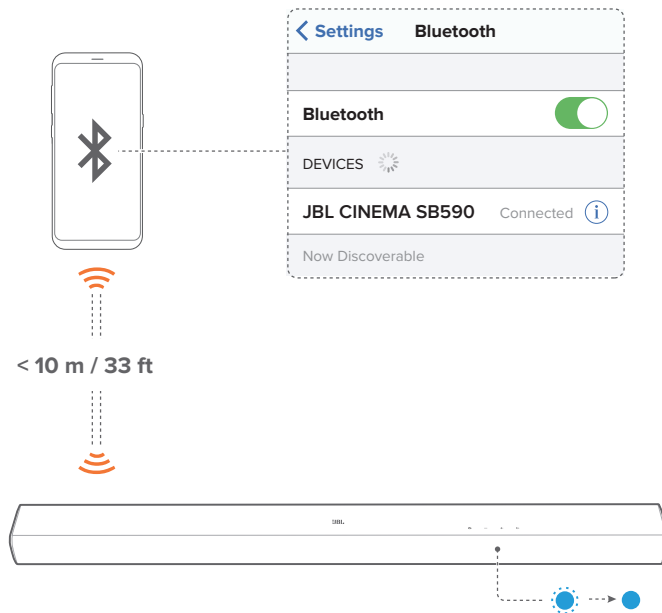

5.2.1 Connect a Bluetooth device

1. Press $\text{\textcircled{P}}$ to switch on (See [“6.1 Power-on/Auto standby/Auto wakeup”](#)).
2. To select the Bluetooth source, press $\text{\textcircled{B}}$ repeatedly on the soundbar or $\text{\textcircled{B}}$ on the remote control.
→ **Ready for pairing:** The status indicator flashes blue quickly ($\text{\textcircled{B}}$).

3. On your Bluetooth device, enable Bluetooth and search for “JBL CINEMA SB590” within three minutes.
→ **Connected:** The status indicator turns solid blue ($\text{\textcircled{B}}$). A confirmation tone is heard.

5.2.2 Reconnect the last paired device

Your Bluetooth device is retained as a paired device when the soundbar goes to standby mode. Next time you switch to the Bluetooth source, the soundbar reconnects the last paired device automatically.

5.2.3 Connect to another Bluetooth device

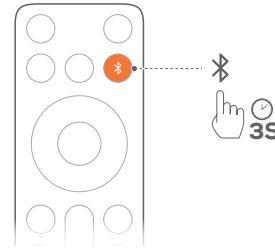

1. In the Bluetooth source, hold $\text{\textcircled{B}}$ on the soundbar or $\text{\textcircled{B}}$ on the remote control until the status indicator flashes blue.
→ The soundbar enters the Bluetooth pairing mode.
2. Follow Step 3 under [“5.2.1 Connect a Bluetooth device”](#).
 - If the device has ever been paired with the soundbar, first unpair “JBL CINEMA SB590” on the device.

NOTES:

- The Bluetooth connection will be lost if the distance between the soundbar and Bluetooth device exceeds 10 m / 33 ft.
- Electronic devices may cause radio interference. Devices that generate electromagnetic waves must be kept away from the soundbar, such as microwaves and wireless LAN devices.

6. PLAY

6.1 Power-on/Auto standby/Auto wakeup

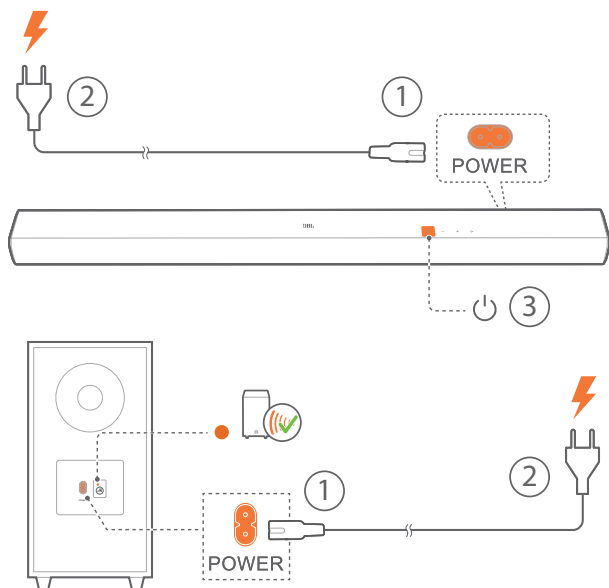

Switch on

1. Connect the soundbar and subwoofer to power by using the supplied power cords.
2. To switch on, press on the soundbar or on the remote control.
 - The subwoofer is connected to the soundbar automatically.
 - **Connected:** The connection status indicator turns solid amber (●).

NOTES:

- Use the supplied power cord only.
- Before switching on the soundbar, make sure that you have completed all other connections (See “[5.1 Connection with your TV and digital devices](#)”).

Auto standby

If the soundbar is inactive for more than 10 minutes, it will switch to standby mode automatically. The subwoofer also goes to standby, and the connection status indicator slowly flashes amber (●).

→ Next time you switch on the soundbar, it returns to the last selected source.

Auto wakeup

In standby mode, the soundbar will wake up automatically when

- the soundbar is connected to your TV through the HDMI ARC/eARC connection and your TV is switched on;
- the soundbar is connected to your TV through an optical cable and audio signals are detected from the optical cable.

6.2 Play from the TV source

With the soundbar connected, you can enjoy TV audio from the soundbar speakers.

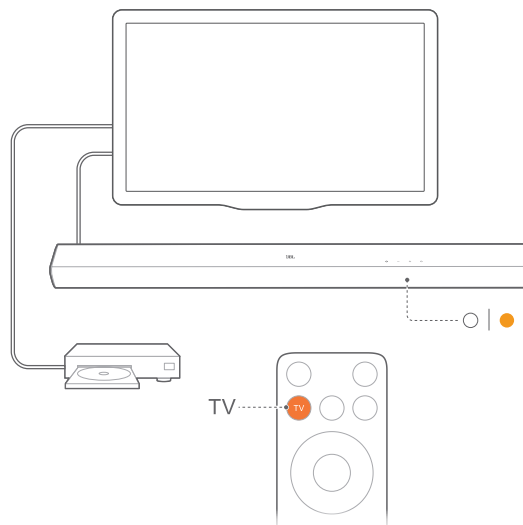

1. Make sure that your TV is set to support external speakers and the built-in TV speakers are disabled. Refer to the owner's manual of your TV for more information.
2. Make sure that the soundbar has been properly connected to your TV (See “[5.1 Connection with your TV and digital devices](#)”).
3. To select the TV source, press repeatedly on the soundbar or **TV** on the remote control.
 - When playing through an HDMI ARC/eARC cable, the status indicator turns solid white (○).
 - When playing through an optical cable, the status indicator turns solid amber (●).

6.2.1 TV remote control setup

To use your TV remote control for both your TV and the soundbar, check that your TV supports HDMI-CEC. If your TV does not support HDMI-CEC, follow the steps under “[6.2.2 TV remote control learning](#)”.

HDMI-CEC

If your TV supports HDMI-CEC, enable the functions as instructed in your TV's user manual. You can control the volume +/-, sound source, and power on/standby functions on your soundbar through the TV remote control.

6.2.2 TV remote control learning

Through IR learning, you can program the soundbar to accept IR commands from your TV remote control, and then use your TV remote control for simple commands.

1. Press to switch on.
2. Hold and **+** together for more than 10 seconds until the status indicator flashes amber.
 - The soundbar enters the TV remote control learning mode.

3. Point your TV remote control at the soundbar. Follow the instructions below:
 - a) On the soundbar, hold one of these buttons: +, -, ⏪ and ⏩ until the status indicator flashes red three times.
 - b) On your TV remote control, press the desired button twice.
 - When the status indicator on the soundbar flashes amber, the function of the soundbar button is learnt by your TV remote control button.
4. Repeat Step 3 to complete the button learning.
5. To exit the TV remote control learning mode, hold ⏩ and + on the soundbar until the status indicator flashes amber three times.

6.3 Play from the HDMI IN source

With the soundbar connected as shown, your digital device can play video on your TV and audio from the soundbar speakers.

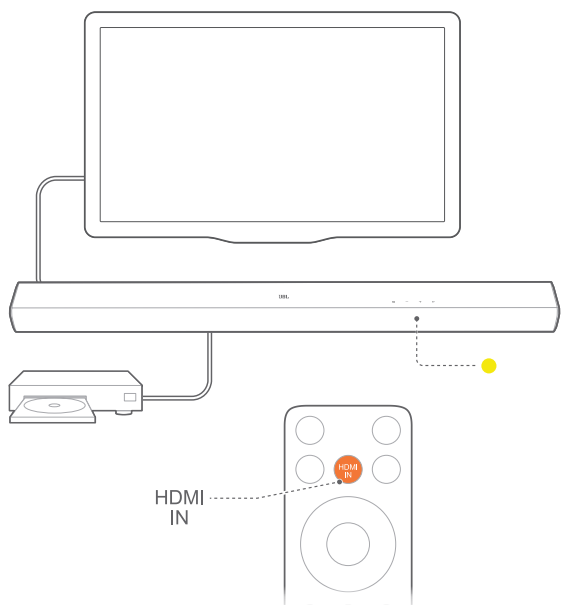

1. Make sure that the soundbar has been properly connected to your TV and digital device (See [“5.1 Connection with your TV and digital devices”](#)).
2. Switch on your digital device.
 - Your TV and the soundbar wake up from standby mode and switch to the input source automatically.
 - To select the HDMI IN source on the soundbar, press ⏪ on the soundbar repeatedly or **HDMI IN** on the remote control.
 - The status indicator turns solid yellow (●), if you play from the HDMI IN source.

NOTES:

- Full compatibility with all HDMI-CEC devices is not guaranteed.
- When your connected TV switches to standby mode, both the soundbar and the source device will enter the standby mode.

6.4 Play from the Bluetooth source

Through Bluetooth, stream audio from your Bluetooth device to the soundbar.

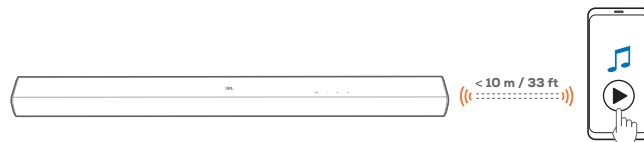

1. Check that the soundbar has been properly connected to your Bluetooth device (See [“5.2 Bluetooth connection”](#)).
2. To select the Bluetooth source, press ⏪ repeatedly on the soundbar or ⏪ on the remote control.
3. Start audio play on your Bluetooth device.
4. Adjust the volume on the soundbar or your Bluetooth device.

6.4.1 Control music playback

In Bluetooth mode, you can control music playback through the buttons on the remote control or on the soundbar.

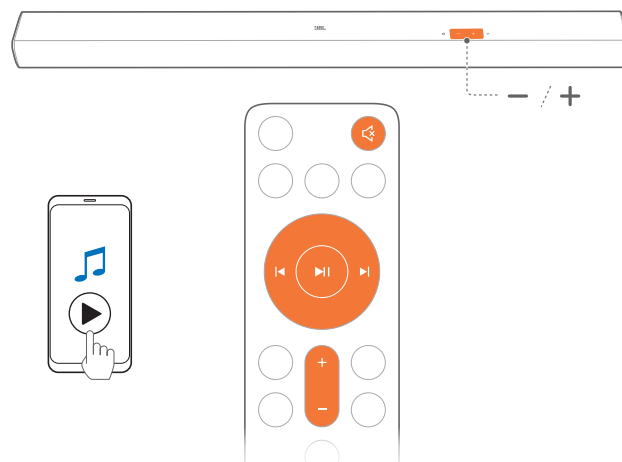

| Button | Function |
|----------|----------------------------------|
| ⏪ | Skip to the previous track. |
| ⏩ | Skip to the next track. |
| ⏸ | Start or pause playback. |
| + / - | Increase or decrease the volume. |
| 🔇 (Mute) | Mute or unmute. |

7. SOUND SETTINGS

7.1 Dolby Atmos (Virtual)

With the Virtual Dolby Atmos, enjoy height sound effects when you play movies in the HDMI IN / HDMI eARC/ARC source.

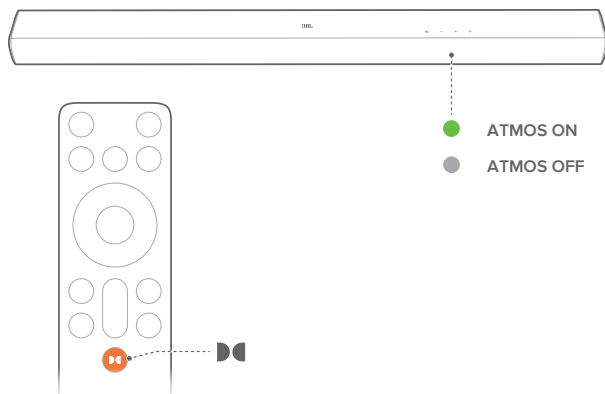

1. Connect and play your Blu-ray player or streaming device through the **TV ARC/TV eARC** connector and the **HDMI IN** connector. (See [“5.1 Connection with your TV and digital devices”](#)).
2. Press **ATMOS** on the remote control to switch the Dolby Atmos sound effect on or off (**Default: on**).
 - The status indicator turns solid green (●), if the Dolby Atmos sound effect is enabled.

NOTE:

- Switch off the Dolby Atmos effect if you prefer not to have any height sound effects while viewing or listening.

7.2 Pre-defined EQ settings

With the remote control, select the pre-defined EQ (equalizer) effects to suit your video or music.

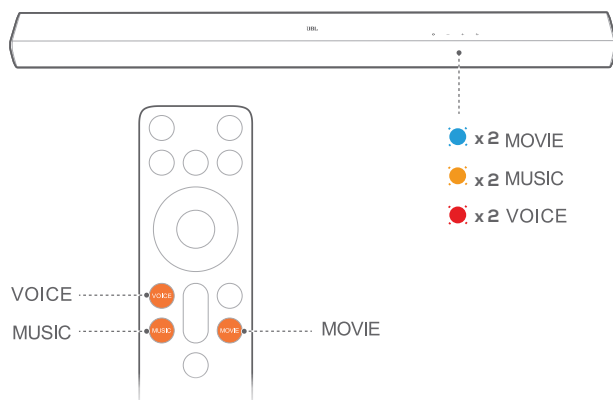

- **MOVIE:** sound mode for movies
 - The status indicator slowly flashes blue twice (●), if the movie mode is enabled on the soundbar.

- **MUSIC:** sound mode for music
 - The status indicator slowly flashes amber twice (●), if the music mode is enabled on the soundbar.
- **VOICE:** sound mode for TV programs such as news and weather forecasts
 - The status indicator slowly flashes red twice (●), if the voice mode is enabled on the soundbar.

7.3 Bass adjustment

You can make bass adjustment as needed.

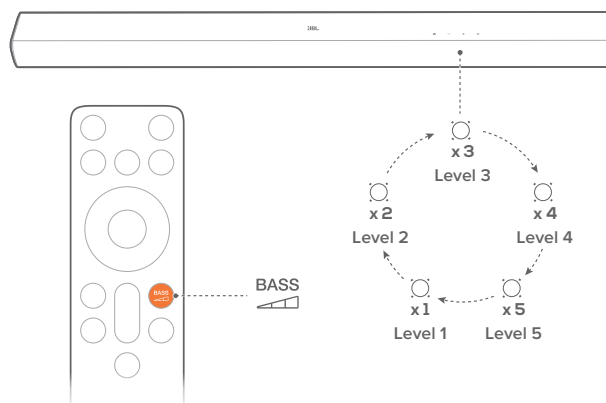

- On the remote control, press **BASS** to toggle between bass levels: Level 1, 2, 3, 4, 5 (**Default: “Level 3”**).

8. RESTORE FACTORY SETTINGS

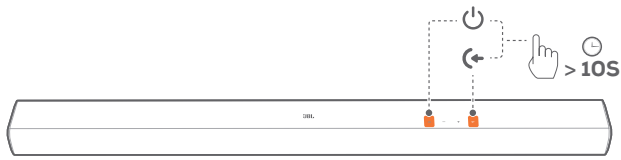

1. Press to switch on.
2. Hold and on the soundbar for more than 10 seconds to restore factory settings.
→ All your personalized settings will be removed from the soundbar.

9. RE-CONNECT THE SUBWOOFER

The soundbar and subwoofer are paired at factories. After power-on, they are paired and connected automatically. In some special cases, you may need to pair them again.

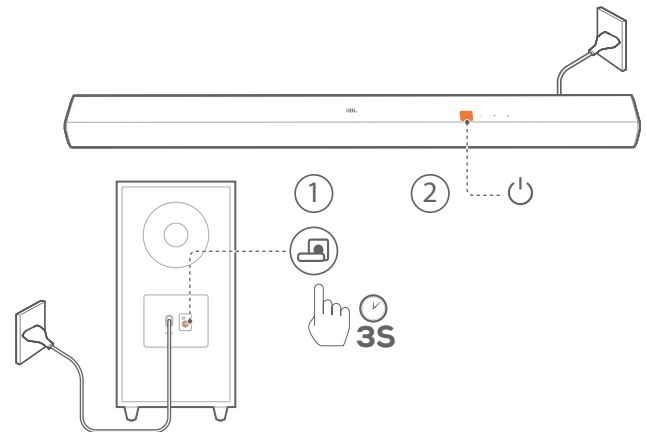

1. On the subwoofer, hold until the connection status indicator flashes amber quickly ().
2. On the soundbar, press to switch on.
→ The subwoofer is connected to the soundbar automatically.
Connected: The connection status indicator turns solid amber ().

NOTE:

- If the wireless connection fails again, check if there is a conflict or strong interference (e.g. interference from an electronic device) around the location. Remove these conflicts or strong interferences and repeat the above procedures.

10. PRODUCT SPECIFICATIONS

General specification:

- Model: CINEMA SB590
- Sound system: 3.1 channel
- Power supply: 100 - 240 V AC, ~ 50/60 Hz
- Total speaker power output (Max @THD 1%): 440 W
- Soundbar output power (Max @THD 1%): 240 W
- Subwoofer output power (Max. @THD 1%): 200 W
- Soundbar transducer: 3x (45 x 100) mm racetrack drivers + 3x 13 mm tweeters
- Subwoofer transducer: 6.5" (165 mm), wireless subwoofer
- Standby power: < 0.5 W
- Operating temperature: 0°C - 45 °C

HDMI specification

- HDMI video input: 1
- HDMI video output (with Enhanced Audio Return Channel, eARC): 1
- HDMI HDCP version: 2.3

Audio specification

- Frequency response: 40Hz - 20 kHz (-10 dB)
- Audio inputs: 1 Optical, Bluetooth and USB (USB playback is available in US version. For other versions, USB is for Service only.)

USB specification

- USB port: Type A
- USB rating: 5V DC, 0.5A
- Supporting file formats: mp3
- MP3 codec: MPEG 1 Layer 2/3, MPEG 2 Layer 3, MPEG 2.5 Layer 3
- MP3 sampling rate: 16 - 48 kHz
- MP3 bitrate: MPEG 1 Layer 1: 32 kbps - 448 kbps;
MPEG 1 Layer 2: 32 kbps - 384 kbps;
MPEG 1 Layer 3: 32 kbps - 320 kbps;
MPEG 2/2.5 Layer 1: 32 kbps - 256 kbps;
MPEG 2/2.5 Layer 2/3: 8 kbps - 160 kbps

Wireless specification

- Bluetooth version: 5.3
- Bluetooth profile: A2DP 1.3, AVRCP 1.6
- Bluetooth transmitter frequency range: 2400 MHz - 2483.5 MHz
- Bluetooth Max. transmitting power: <10 dBm (EIRP)
- Bluetooth modulation: GFSK, $\pi/4$ DQPSK, 8DPSK
- 2.4G wireless transmitter frequency range: 2402 - 2481 MHz
- 2.4G wireless transmitter power: <10 dBm (EIRP)
- 2.4G wireless modulation: GFSK

Dimensions

- Soundbar dimensions (W x H x D): 950 x 64 x 80 mm / 37.4" x 2.5" x 3.1"
- Subwoofer dimensions (W x H x D): 200 x 404 x 250 mm / 7.9" x 15.9" x 9.9"
- Soundbar weight: 2.6 kg / 5.7 lbs
- Subwoofer weight: 5.7 kg / 12.6 lbs
- Packaging dimensions (W x H x D): 1025 x 235 x 397 mm / 40.4" x 9.3" x 15.6"
- Packaging weight: 10.4 kg / 22.9 lbs

11. TROUBLESHOOTING

Never try to repair the product yourself. If you have problems using this product, check the following before you request services.

System

The unit will not turn on.



- Check if the power cord is plugged into power and the soundbar.

The soundbar has no response to button pressing.

- Restore the soundbar to factory settings (See "[8. RESTORE FACTORY SETTINGS](#)").

Sound

No sound from the soundbar

- Make sure that the soundbar is not muted.
- Select the correct audio input source on the remote control.
- Connect the soundbar to your TV or other devices properly.
- Restore the soundbar to its factory settings by holding  and  on the soundbar for more than 10 seconds.

Distorted sound or echo

- If you play audio from your TV through the soundbar, make sure that your TV is muted or the built-in TV speaker is disabled.

No height sound effects of Dolby Atmos

- If your TV supports HDMI ARC only, make sure that you have connected your digital device to the soundbar through the **HDMI IN** connector on the soundbar (See "[5.1.2 TV \(HDMI ARC\)](#)").
- Enjoy the sound effects of Dolby Atmos when you play movies from the TV / HDMI source. For audio streaming over Bluetooth, Dolby Atmos is not supported.

Bluetooth

A device cannot be connected with the soundbar.

- Check if you have enabled Bluetooth on the device.
- If the soundbar has been paired with another Bluetooth device, reset Bluetooth (see "[5.2.3 Connect to another Bluetooth device](#)").

Poor audio quality from a connected Bluetooth device

- The Bluetooth reception is poor. Move the source device closer to the soundbar, or remove any obstacle between the source device and the soundbar.

The connected Bluetooth device connects and disconnects constantly.

- The Bluetooth reception is poor. Move the source device closer to the soundbar, or remove any obstacle between the source device and the soundbar.
- For some Bluetooth devices, the Bluetooth connection can be deactivated automatically to save power. This does not indicate any malfunction of the soundbar.

Remote control

The remote control does not work.

- Check if the batteries are drained. If so, replace them with new ones.
- Reduce the distance and angle between the remote control and the main unit.

Failed to complete the TV remote control learning.

- Check if you are using an infra-red TV remote control. The IR learning is not supported by a Bluetooth TV remote control.

12. TRADEMARKS



The Bluetooth® word mark and logos are registered trademarks owned by Bluetooth SIG, Inc. and any use of such marks by HARMAN International Industries, Incorporated is under license. Other trademarks and trade names are those of their respective owners.



The terms HDMI, HDMI High-Definition Multimedia Interface, HDMI trade dress and the HDMI Logos are trademarks or registered trademarks of HDMI Licensing Administrator, Inc.



Dolby, Dolby Atmos, and the double-D symbol are registered trademarks of Dolby Laboratories Licensing Corporation. Manufactured under license from Dolby Laboratories. Confidential unpublished works.

Copyright © 2012-2021 Dolby Laboratories. All rights reserved.



HARMAN International Industries,
Incorporated 8500 Balboa Boulevard,
Northridge, CA 91329 USA
www.jbl.com

© 2024 HARMAN International Industries, Incorporated.

All rights reserved.

JBL is a trademark of HARMAN International Industries, Incorporated, registered in the United States and/or other countries. Features, specifications and appearance are subject to change without notice.